

# TRANSLATION OF THE ORIGINAL OPERATING INSTRUCTIONS

IMPORTANT

READ CAREFULLY BEFORE USE

KEEP SAFE TO CONSULT AT A LATER DATE



# HERCULES



# BOSCH



Operating instructions for HERCULES BROSE Topology MY21

PASERO COMP I-12, PASERO COMP I-F5, PASERO PRO I-12, PASERO SPORT I-10, PASERO SUV I-10

21-Q-0023, 21-Q-0024, 21-Q-0025, 21-Q-0026, 21-Q-0027, 21-Q-0028, 21-Q-0029, 21-Q-0030, 21-Q-0031, 21-Q-0032, 21-Q-0033, 21-Q-0079, 21-Q-0080

# Contents

1	About these operating instructions	6	3.1.3	Brake system	18
1.1	Manufacturer	6	3.1.3.1	Disc brake	18
1.2	Language	6	3.1.4	Electric drive system	19
1.3	Laws, standards and directives	6	3.1.4.1	Motor	19
1.4	For your information	6	3.1.4.2	Rechargeable battery	19
1.4.1	Warnings	6	3.1.5	On-board computer	20
1.4.2	Markups	7	3.1.5.1	Operating element	20
1.5	Nameplate	8	3.2	Proper use	21
1.6	Type number and model	9	3.3	Improper use	22
1.7	Identifying the operating instructions	9	3.3.1	Maximum permitted total weight	23
2	Safety	10	3.4	Technical data	24
2.1	Residual risks	10	3.4.1	Pedelec	24
2.1.1	Risk of fire and explosion	10	3.4.2	Brose Drive S motor	24
2.1.1.1	Rechargeable battery	10	3.4.3	Brose Drive T motor	24
2.1.1.2	Overheated charger	10	3.4.4	Brose Topology on-board computer	24
2.1.1.3	Hot components	10	3.4.5	SuperCore 750 battery	24
2.1.2	Electric shock	10	3.4.6	SuperCore 555 battery	25
2.1.2.1	Damage	10	3.4.7	Emissions	25
2.1.2.2	Water penetration	10	3.4.8	Tightening torque	25
2.1.2.3	Bridging	10	3.5	Description of controls and screens	26
2.1.3	Risk of a crash	11	3.5.1	Handlebars	26
2.1.3.1	Incorrect quick release setting	11	3.5.2	On-board computer	26
2.1.3.2	Incorrect tightening torque	11	3.5.2.1	<Home screen>	26
2.1.4	Risk of amputation	11	3.5.2.2	<Set screen>	27
2.1.5	Key breaking off	11	3.5.2.3	Daytime and night mode	28
2.2	Toxic substances	11	3.5.2.4	System message	28
2.2.1	Brake fluid	11	3.5.3	Battery level indicator (rechargeable battery)	28
2.2.2	Suspension oil	11	3.6	Environmental requirements	29
2.2.3	Defective battery	11	4	Transportation and storing	31
2.3	Requirements for the rider	11	4.1	Physical transport characteristics	31
2.4	Vulnerable groups	11	4.2	Designated handles/lifting points	31
2.5	Personal protective equipment	12	4.3	Transportation	32
2.6	Safety markings and safety instructions	12	4.3.1	Using the brake transport securing system	32
2.7	What to do in an emergency	12	4.3.2	Transporting the pedelec	32
2.7.1	Dangerous situation in road traffic	12	4.3.3	Shipping a pedelec	32
2.7.2	Leaked brake fluid	12	4.3.4	Transporting the battery	32
2.7.3	Battery vapours emitted	13	4.3.5	Shipping the battery	32
2.7.4	Battery fire	13	4.4	Storing	33
2.7.5	Leaked brake fluid	13	4.4.1	Storage mode	33
2.7.6	Oil and lubricant leaks from the fork	13	4.4.1.1	Activating	33
2.7.7	Oil and lubricant leaks from the rear frame damper	13	4.4.1.2	Deactivating	33
3	Overview	14	4.4.2	Break in operation	33
3.1	Description	15	4.4.2.1	Preparing a break in operation	33
3.1.1	Wheel	15	4.4.2.2	Carrying out a break in operation	33
3.1.1.1	Valve	15	5	Assembly	34
3.1.2	Suspension	15	5.1	Required tools	34
3.1.2.1	Rigid fork	15	5.2	Unpacking	34
3.1.2.2	Suspension fork	15	5.2.1	Scope of delivery	34
3.1.2.3	Steel suspension fork	17			
3.1.2.4	Air suspension fork	17			

5.3	Commissioning	34	6.12	Rechargeable battery	55
5.4	Preparing the battery	35	6.12.1	Removing the battery	55
5.4.1	Checking the battery	35	6.12.2	Inserting the battery	55
5.4.2	Retrofitting the battery locking lever	35	6.12.3	Charging the battery	56
5.4.2.1	Preparing the frame	35	6.12.4	Waking the battery	56
5.4.2.2	Fitting the locking lever	36	6.13	Electric drive system	57
5.4.3	Installing the wheel in the Suntour fork	36	6.13.1	Switching on the electric drive system	57
5.4.4	Checking the stem and handlebars	37	6.13.2	Switching off the drive system	57
5.4.4.1	Checking the connections	37	6.14	On-board computer	58
5.4.4.2	Firm hold	37	6.14.1	Switching the on-board computer on	58
5.4.4.3	Checking the headset backlash	37	6.14.2	Switching off the on-board computer	58
5.5	Pedelec sale	37	6.14.3	Using the riding light	58
6	Operation	38	6.14.4	Using the push assist system	59
6.1	Risks and hazards	38	6.14.5	Selecting the level of assistance	59
6.2	Personal protective equipment	39	6.14.6	Switching the journey information	60
6.3	Tips for a greater range	40	6.14.7	Changing the system information	60
6.4	Error messages	41	6.14.7.1	Setting background colour	60
6.4.1	Error message display	41	6.14.7.2	Setting units	61
6.5	Instruction and customer service	43	6.14.7.3	Adjusts the backlight	61
6.6	Adjusting the pedelec	43	6.14.7.4	Setting the clock	61
6.6.1	Adjusting the saddle	43	6.14.7.5	Switching the PIN prompt on and off	62
6.6.1.1	Adjusting the saddle tilt	43	6.14.7.6	Changing the PIN	62
6.6.1.2	Determining the seat height	43	6.14.7.7	Resetting the settings	63
6.6.1.3	Adjusting the seat height with quick release	44	6.15	Brake	64
6.6.1.4	Adjusting the seat position	44	6.15.1	Using the brake lever	64
6.6.2	Adjusting the handlebars	45	6.16	Suspension and damping	65
6.6.3	Adjusting the stem	45	6.16.1	Suspension fork compression adjuster	65
6.6.3.1	Adjusting the height of the handlebars	45	6.16.1.1	Adjusting the Suntour compression adjuster	66
6.6.3.2	Adjusting the quick release clamping force	45	6.17	Gear shift	67
6.6.4	Adjusting the brake	45	6.17.1	Using the derailleur gears	67
6.6.4.1	Retracting the brake linings	46	6.18	Parking the pedelec	68
6.6.5	Adjusting the damping sag	46	7	Cleaning and servicing	69
6.6.5.1	Adjusting the Suntour fork steel suspension	46	7.1	Cleaning after each ride	69
6.6.5.2	Adjusting the Suntour fork air suspension	47	7.1.1	Cleaning the suspension fork	69
6.6.6	Adjusting the rebound damping	48	7.1.2	Cleaning the rear frame damper	69
6.6.6.1	Adjusting the Suntour air suspension fork	49	7.1.3	Cleaning the pedals	69
6.7	Accessories	50	7.2	Basic cleaning	70
6.7.1	Child seat	50	7.2.1	Cleaning the frame	70
6.7.2	Trailer	51	7.2.2	Cleaning the stem	70
6.7.2.1	Trailer approval for Enviolo hub gear	51	7.2.3	Cleaning the wheel	70
6.7.3	Pannier rack	52	7.2.4	Cleaning the drive elements	70
6.7.4	Mobile holder	52	7.2.5	Cleaning the rear frame damper	70
6.7.5	Suspension fork coil spring	52	7.2.6	Cleaning the chain	71
6.7.6	Tubeless and airless	52	7.2.7	Cleaning the battery	71
6.8	Check list before each ride	53	7.2.8	Cleaning the on-board computer	71
6.9	Raising the kickstand	54	7.2.9	Cleaning the motor	71
6.10	Using the pannier rack	54	7.2.10	Cleaning the brake	72
6.11	Using the saddle	54	7.3	Servicing	72
			7.3.1	Servicing the frame	72
			7.3.2	Servicing the stem	72
			7.3.3	Servicing the fork	72

7.3.4	Servicing the drive elements	72	9.2	Repair	91
7.3.5	Servicing the pedals	72	9.2.1	Original parts and lubricants	91
7.3.6	Servicing the chain	72	9.2.2	Replacing the lighting	91
7.4	Maintenance	73	9.2.3	Adjusting the headlight	91
7.4.1	Wheel	73	9.2.4	Tyre clearance check	91
7.4.1.1	Checking the tyres	73	10	Recycling and disposal	92
7.4.1.2	Checking the rims	73	11	Documents	93
7.4.1.3	Checking and adjusting the tyre pressure – Dunlop valve	73	11.1	Parts list	93
7.4.1.4	Checking and adjusting the tyre pressure – Presta valve	74	11.1.1	PASERO PRO I-12	93
7.4.1.5	Checking and adjusting the tyre pressure – Schrader valve	74	11.1.2	PASERO COMP I-12	94
7.4.2	Brake system	74	11.1.3	PASERO COMP I-F5	95
7.4.3	Checking the brake linings for wear	74	11.1.4	PASERO SPORT I-10	96
7.4.4	Checking the pressure point	74	11.1.5	PASERO SUV I-10	97
7.4.5	Checking the brake discs for wear	74	11.2	Assembly report	98
7.4.6	Checking the electrical cables and brake cables	75	11.3	Maintenance instructions	100
7.4.7	Checking the gear shift	75	11.4	SuperCore drilling template	104
7.4.8	Checking the stem	75	12	Glossary	105
7.4.9	Checking the belt and chain tension	75	12.1	Abbreviations	107
8	Maintenance	76	12.2	Simplified terms	107
8.1	Suspension system	77	13	Appendix	108
8.1.1	Rear frame damper	77	I.	Translation of the original EC/EU Declaration of Conformity	108
8.1.2	Suspension fork	78	14	Keyword index	109
8.1.3	Suspension seat post	79			
8.2	Axle with quick release	79			
8.2.1	Checking the quick release	80			
8.3	Maintaining the stem	80			
8.4	Adjusting the gear shift	80			
8.4.1	Cable-operated gear shift, single-cable	80			
8.4.2	Cable-operated gear shift, dual-cable	81			
8.4.3	Cable-operated twist grip, dual-cable	81			
9	Troubleshooting, fault clearance and repair	82			
9.1	Troubleshooting and fault clearance	82			
9.1.1	The drive system or display do not start up	82			
9.1.2	Error message	82			
9.1.3	Assistance function errors	83			
9.1.4	Battery error	84			
9.1.5	Display errors	85			
9.1.6	Lighting does not work	85			
9.1.7	Other errors	86			
9.1.8	Suspension fork	87			
9.1.8.1	Rebound too fast	87			
9.1.8.2	Rebounding too slowly	88			
9.1.8.3	Suspension too soft on inclines	89			
9.1.8.4	Excessively hard damping on bumps	90			

**Thank you for your trust!**

HERCULES pedelecs are premium quality bicycles. You have made an excellent choice. Your specialist dealer will provide you with guidance and instruction and assemble your product. Your specialist dealer will also be happy to assist you in the future whether you require maintenance, conversion or repair.

**Notice**

These *operating instructions* are not a substitute for personal instruction by the supplying specialist dealer.

These operating instructions are an integral part of the pedelec. Therefore, if it is re-sold at a later time, they must be handed over to the subsequent owner.

You are receiving these operating instructions with your new pedelec. Please take time to become familiar with your new pedelec and follow the tips and suggestions in the operating instructions. They will help you to enjoy your pedelec for a long time to come. We hope you have fun and wish you well on all of your rides!

These operating instructions are mainly designed for the rider or the operator. They aim to ensure that non-professionals can use the pedelec safely.



Sections are also designed especially for the specialist dealer. These sections aim to ensure that specialist dealers complete initial assembly and maintenance safely and reliably. The sections for specialist dealers are highlighted in grey and marked with a spanner symbol.



Download the operating instructions onto your phone at the following link, so that you can use them when you are out riding:

<https://www.hercules-bikes.de/de/de/index/downloads.html>

**Copyright**

© HERCULES GmbH

Distribution or reproduction of these operating instructions and utilisation or communication of their content is prohibited unless expressly approved. Any infringement will render the offender liable for compensation. All rights reserved in the event that a patent, utility model or industrial design is registered.

**Editing**

Text and images:  
ZEG Zweirad-Einkaufs-Genossenschaft eG  
Longericher Straße 2  
50739 Köln, Germany

**Translation**

RKT Übersetzungs- und Dokumentations-GmbH  
Markenstrasse 7  
40227 Düsseldorf, Germany

**In case of any questions or problems regarding these operating instructions, please contact:**

tecdoc@hercules-bike.de

# 1 About these operating instructions

## 1.1 Manufacturer

The pedelec manufacturer is:

HERCULES GMBH  
Longericher Straße 2  
50739 Köln, Germany

Tel.: +49 4471 18735 0  
Fax: +49 4471 18735 29  
E-mail: [info@hercules-bikes.de](mailto:info@hercules-bikes.de)  
Website: [www.hercules-bikes.de](http://www.hercules-bikes.de)

Subject to internal changes

The information contained in these *operating instructions* are the approved technical specifications at the time of printing. Any significant changes are included in a new published version of the *operating instructions*. You will find any modifications to these *operating instructions* at:

<https://www.hercules-bikes.de/de/de/index/downloads.htm>

## 1.2 Language

The *original operating instructions* are written in German. A translation is invalid without the *original operating instructions*.

## 1.3 Laws, standards and directives

The *operating instructions* comply with the essential requirements specified in:

- Machinery Directive 2006/42/EC
- Electromagnetic Compatibility Directive 2014/30/EU
- ISO 20607:2018 Safety of machinery – Instruction handbook – General drafting principles
- EN 15194:2018 Cycles – Electrically power assisted cycles – pedelec bicycles
- EN 11243:2016, Cycles – Pannier racks for bicycles – Requirements and test methods
- ISO 17100:2016-05 Translation Services – Requirements for translation services.

## 1.4 For your information

Different markings are used in the operating instructions to make them easier to read.

### 1.4.1 Warnings

Warnings indicate hazardous situations and actions. You will find warnings in the *operating instructions*:



Will lead to serious or even fatal injuries if ignored. High-risk hazard.



May lead to serious or even fatal injuries if ignored. Medium-risk hazard.



May lead to minor or moderate injuries if ignored. Low-risk hazard.

**Notice**

May lead to material damage if ignored.

## 1.4.2 Markups



Instructions for specialist dealers are highlighted in grey. They are indicated by a screwdriver symbol. Information for specialist dealers does not require non-professionals to take any action.

You will find stylised forms of typeface in the *operating instructions*:

Stylised form	Use
<i>Italics</i>	Glossary term
<u>Underlined in blue</u>	Link
<u>Underlined in grey</u>	Cross references
✓ Check marks	Requirements
▶ Triangle	Instruction for action
1 Instruction for action	Several instructions for action in specified order
⇒	Result of the action
SPACED	Indicators on the display screen
•	Bulleted lists
Only applies to pedelecs with this equipment	Each type has a different kind of equipment. A note beneath the heading indicates components which can be used as an alternative.

Table 1: Markups

## 1.5 Nameplate

The nameplate is situated on the frame. You can see the exact position of the nameplate in Figure 2.

You will find thirteen pieces of information on the nameplate.



Figure 1: Example Nameplate

No.	Designation	Description
1	CE marking	The manufacturer uses the CE marking to declare that the pedelec complies with applicable requirements.
2	Manufacturer's contact details	You can contact the manufacturer at the address. You can find more information in Section 1.
3	Type number	All pedelec models have an eight-digit type number, which is used to specify the design model year, the type of pedelec and the version. You can find more information in Section 1.
4	Maximum continuous power	The maximum continuous power is the greatest possible power for the electric motor output shaft over 30 minutes.
5	Maximum permitted total weight	The maximum permitted total weight is the weight of the fully assembled pedelec with the rider and baggage.
6	Year of manufacture	The <i>year of manufacture</i> is the year in which the pedelec was manufactured. The production period is from August 2020 to July 2021.
7	Pedelec type	You can find more information in Section 3.2.
8	Safety markings	You can find more information in Section 1.4.
9	Disposal instructions	You can find more information in Section 10.
10	Area of use	You can find more information in Section 3.6.
11	Model year	The model year refers to the first production year that the series-manufactured pedelec was produced in the version concerned. The year of manufacture is different to the model year in some cases.
12	Weight of the ready-to-ride pedelec	The weight of the ready-to-ride pedelec is specified as a weight of 25 kg or above and refers to its weight at the time of purchase. You must add each additional accessory to the weight.
13	Shut-off speed	The speed that the pedelec reaches at the moment when the current has dropped to zero or to the no-load current value.

Table 2: Nameplate details



## 1.6 Type number and model

These operating instructions are an integral part of pedelecs with the type numbers:

Type no.	Model	Pedelec type
21-Q-0023	PASERO PRO I-12 (Diamant)	City and trekking bicycle
21-Q-0024	PASERO PRO I-12 (Trapez)	City and trekking bicycle
21-Q-0025	PASERO PRO I-12 (central tube)	City and trekking bicycle
21-Q-0026	PASERO COMP I-12 (Diamant)	City and trekking bicycle
21-Q-0027	PASERO COMP I-12 (Trapez)	City and trekking bicycle
21-Q-0028	PASERO COMP I-12 (central tube)	City and trekking bicycle
21-Q-0029	PASERO COMP I-F5 (Diamant)	City and trekking bicycle
21-Q-0030	PASERO COMP I-F5 (central tube)	City and trekking bicycle
21-Q-0031	PASERO SPORT I-10 (Diamant)	City and trekking bicycle
21-Q-0032	PASERO SPORT I-10 (Trapez)	City and trekking bicycle
21-Q-0033	PASERO SPORT I-10 (central tube)	City and trekking bicycle
21-Q-0079	PASERO SUV I-10 (Diamant)	City and trekking bicycle
21-Q-0080	PASERO SUV I-10 (central tube)	City and trekking bicycle

**Table 3: Type number, model and pedelec type**

## 1.7 Identifying the operating instructions

The Identification number position is located on bottom left-hand side on each page. The identification number is composed of the document number, the version number and the release date.

<b>Identification number</b>	MY21H02 - 12_1.0_19.10.2020
------------------------------	-----------------------------

## 2 Safety

### 2.1 Residual risks

#### 2.1.1 Risk of fire and explosion

##### 2.1.1.1 Rechargeable battery

The safety electronics may fail if the batteries are damaged or faulty. The residual voltage can cause a short circuit. The battery may self-ignite and explode.

- ▶ Only use and charge the battery and accessories if they are in perfect condition.
- ▶ Never open or repair the battery.
- ▶ Batteries with external damage must be removed from service immediately.
- ▶ If a battery is dropped or struck, remove it from service and observe it for at least 24 hours.
- ▶ Faulty batteries are hazardous goods. Dispose of faulty batteries in the correct manner. Store battery in a dry place until disposal. Never store in the vicinity of flammable substances.

The battery is only protected from spray water. Penetration by water can cause a short circuit. The battery may self-ignite and explode.

- ▶ Never immerse the battery in water.
- ▶ Put battery out of service if you suspect water has penetrated it.

Temperatures over 60 °C can also cause liquid to leak from the battery and the battery will become damaged. The battery may self-ignite and explode.

- ▶ Protect the battery against heat.
- ▶ Never store next to hot objects.
- ▶ Never expose the battery to sustained direct sunlight.
- ▶ Avoid wide temperature fluctuations.

Chargers with excessive voltage damage batteries. This may result in fire or an explosion.

- ▶ Only use batteries approved for the pedelec. Clearly label the supplied charger.

##### 2.1.1.2 Overheated charger

The charger heats up when charging the battery. In case of insufficient cooling, this can result in fire or burns to the hands.

- ▶ Never use charger on a highly flammable surface.
- ▶ Never cover the charger during charging.
- ▶ Never leave the battery unattended during charging.

##### 2.1.1.3 Hot components

The brakes and the motor may become very hot during operation. There is a risk of burns or fire in case of contact.

- ▶ Never touch the brakes or the motor directly after a ride.
- ▶ Never place the pedelec on a flammable surface, such as grass or wood, directly after use.

#### 2.1.2 Electric shock

##### 2.1.2.1 Damage

Damaged chargers, cables and plug connectors increase the risk of electric shock.

- ▶ Check the charger, cable and plug connector before each use. Never use a damaged charger.

##### 2.1.2.2 Water penetration

If water penetrates into the charger, there is a risk of electric shock.

- ▶ Never charge the battery outdoors.

##### 2.1.2.3 Bridging

Metal objects may interconnect the battery's electrical terminals. The battery may self-ignite and explode.

- ▶ Never insert paper clips, screws, coins, keys and other small parts into the battery.

## 2.1.3 Risk of a crash

### 2.1.3.1 Incorrect quick release setting

Excessively high clamping force will damage the quick release and cause it to lose its function. Insufficient clamping force will result in unfavourable transmission of force. This can cause components to break. This will cause a crash with injuries.

- ▶ Never fasten a quick release using a tool (e.g. hammer or pliers).
- ▶ Only use the clamping lever with the specified set clamping force.

### 2.1.3.2 Incorrect tightening torque

If a screw is fastened too tightly, it may break. If a screw is not fastened enough, it may loosen. This will cause a crash with injuries.

- ▶ Always observe the indicated torque on the screw or in the *operating instructions*.

## 2.1.4 Risk of amputation

The brake disc in disc brakes is so sharp that it can cause serious injuries to fingers if they are inserted into the brake disc openings.

- ▶ Always keep fingers well away from the rotating brake discs.

## 2.1.5 Key breaking off

If you leave a key inserted when riding or transporting the pedelec, it may break off or the locking system may open accidentally.

- ▶ Remove the key to the battery lock.

## 2.2 Toxic substances

### 2.2.1 Brake fluid

Brake fluid may leak out after an accident or due to material fatigue. Brake fluid can be fatal if swallowed or inhaled.

- ▶ Never dismantle the brake system.
- ▶ Avoid contact with skin.
- ▶ Do not inhale vapours.

### 2.2.2 Suspension oil

Suspension oil in the fork and the rear frame damper is toxic to the touch, irritates respiratory tracts and causes cancer, sterility and mutation in germ cells.

- ▶ Never dismantle the rear frame damper or the suspension fork.
- ▶ Avoid contact with skin.

### 2.2.3 Defective battery

Liquids and vapours may leak from damaged or faulty batteries. Excessively high temperatures may also cause liquids and vapours to leak from the battery. Such liquids and vapours can irritate the airways and cause burns.

- ▶ Never dismantle the battery.
- ▶ Avoid contact with skin.
- ▶ Do not inhale vapours.

## 2.3 Requirements for the rider

The rider must demonstrate adequate physical, motor and mental abilities to ride on public roads. A minimum age of 14 years is recommended.

## 2.4 Vulnerable groups

Keep batteries and charger away from children and people with reduced physical, sensory or mental capabilities or lacking in experience and knowledge.

If minors use the pedelec, a legal guardian must should provide them with comprehensive instructions.

## 2.5 Personal protective equipment

Wear a suitable cycling helmet, sturdy footwear and typical close-fitting clothing to provide protection.

## 2.6 Safety markings and safety instructions

The nameplate contains these safety markings and safety instructions:



Symbol	Explanation
	General warning
	Adhere to the instructions for use

Table 4: Meaning of safety markings











Symbol	Explanation
	Read the instructions
	Separate collection of electrical and electronic devices
	Separate collection of ordinary and rechargeable batteries
	Must not be thrown into fire (burning prohibited)
	It is forbidden to open any batteries
	Device of protection class II
	Only suitable for use indoors
	Fuse (device fuse)
	EU conformity
	Recyclable material
	Protect from temperatures above 50 °C and direct sunlight

Table 5: Safety instructions

## 2.7 What to do in an emergency

### 2.7.1 Dangerous situation in road traffic

- ▶ In the event of any hazards or dangers in road traffic, apply the brakes on the pedelec until it comes to a halt. The brake acts as an emergency stop system in such cases.

### 2.7.2 Leaked brake fluid

- ▶ Remove those affected from the danger area to fresh air.
- ▶ Never leave those affected unattended.
- ▶ Immediately remove any clothing items contaminated with brake fluid.
- ▶ Never inhale vapours. Ensure sufficient ventilation.
- ▶ Wear gloves and safety gloves as protective equipment.
- ▶ Keep unprotected persons away.
- ▶ Take care with leaked brake fluid as it poses a slip hazard.
- ▶ Keep leaked brake fluid away from naked flames, hot surfaces and sources of ignition.
- ▶ Avoid contact with skin and eyes.

#### After inhalation

- ▶ Take in fresh air. Immediately consult a doctor in case of any discomfort.

#### After skin contact

- ▶ Wash affected skin with soap and water and rinse well. Remove contaminated clothing. Consult doctor in the event of pain or discomfort.

#### After contact with eyes

- ▶ Rinse eyes under flowing water for at least ten minutes with the lids open; also rinse under lids. Immediately consult a doctor in case of any pain or discomfort.

#### After swallowing

- ▶ Rinse out mouth with water. Never induce vomiting. Risk of aspiration!
- ▶ If a person is lying on their back and vomiting, place them in the recovery position. Seek medical advice immediately.

## Environmental protection measures

- ▶ Never allow brake fluid to flow into the sewage system, water courses or groundwater.
- ▶ Notify the relevant authorities if fluid penetrates the ground, water courses or the sewage system.
- ▶ Consult a doctor immediately in the event of any pain or discomfort caused by combustion gas or leaking fluids.

### 2.7.3 Battery vapours emitted

Vapours may be emitted if the battery is damaged or used improperly. The vapours may cause respiratory tract irritation.

- ▶ Get into fresh air.
- ▶ Consult doctor in the event of pain or discomfort.

### After contact with eyes

- ▶ Carefully rinse eyes with plenty of water for at least 15 minutes. Protect unaffected eye. Seek medical advice immediately.

### After skin contact

- ▶ Remove any solid particles immediately.
- ▶ Rinse the affected area with plenty of water for at least 15 minutes. Then dab the affected skin gently. Do not rub dry.
- ▶ Remove contaminated clothing immediately.
- ▶ Immediately consult a doctor if there is any redness, pain or discomfort.

### 2.7.4 Battery fire

The safety electronics may fail if the battery is damaged or faulty. The residual voltage can cause a short circuit. The battery may self-ignite and explode.

- 1 Keep your distance if the battery becomes deformed or starts to emit smoke.
  - 2 If charging, remove the plug connector from the socket.
  - 3 Contact the fire service immediately.
- ▶ Use Class fire extinguishers to put out the fire.
  - ▶ Never extinguish damaged batteries with water or allow them to come into contact with water.

Inhaling vapours can cause intoxication.

- ▶ Stand on the side of the fire where the wind is blowing from.
- ▶ Use breathing apparatus if possible.

### 2.7.5 Leaked brake fluid

The brake system must be repaired immediately if brake fluid leaks out. Dispose of leaking brake fluid in an environmentally responsible way in accordance with statutory regulations.

- ▶ Contact your specialist dealer.

### 2.7.6 Oil and lubricant leaks from the fork

Dispose of oils and lubricants which have leaked from the rear frame damper in an environmentally responsible way in compliance with statutory regulations.

- ▶ Contact your specialist dealer.

### 2.7.7 Oil and lubricant leaks from the rear frame damper

Dispose of oils and lubricants which have leaked from the rear frame damper in an environmentally responsible way in accordance with statutory regulations.

- ▶ Contact your specialist dealer.

### 3 Overview

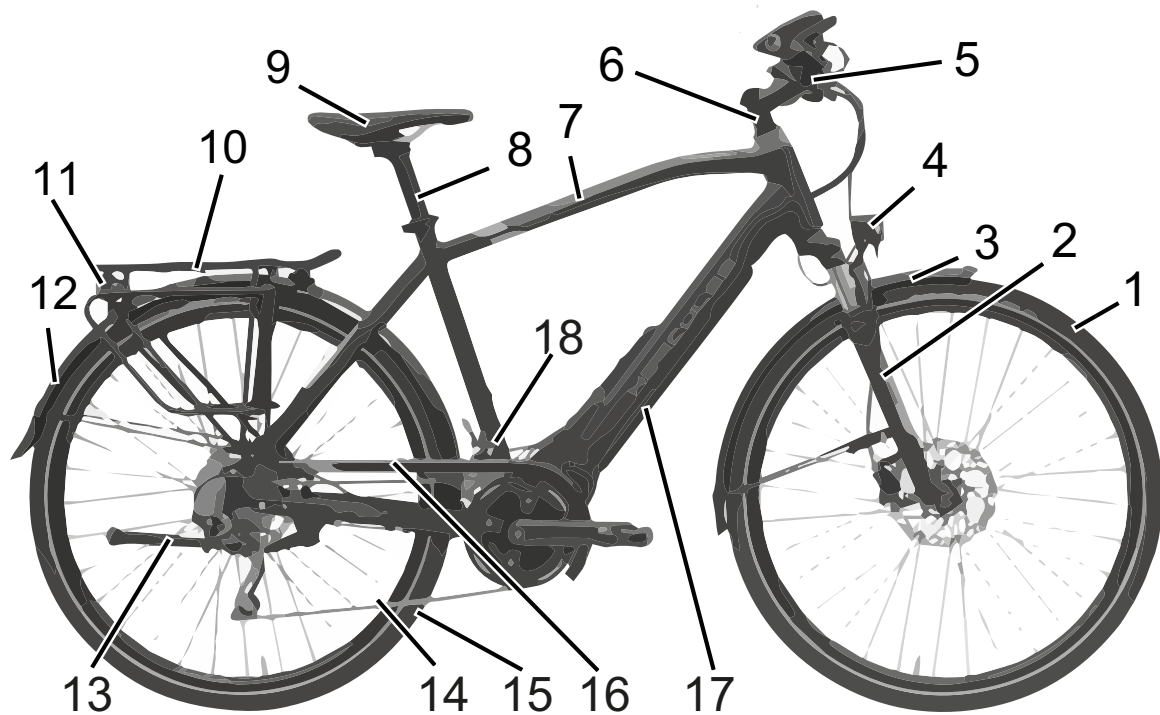

Figure 2: Pedelec on right, Pasero

1	<i>Front wheel</i>	11	Rear light and reflector
2	<i>Fork</i>	12	Rear mudguard
3	Front mudguard	13	Kickstand
4	Headlight	14	Chain
5	<i>Handlebars</i>	15	Rear wheel
6	<i>Stem</i>	16	Chain guard
7	Frame	17	Battery with nameplate
8	Seat post	18	<i>Frame number</i>
9	Saddle		
10	Pannier rack		

### 3.1 Description

#### 3.1.1 Wheel

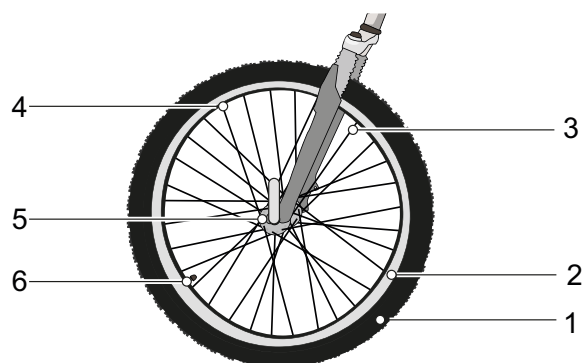

Figure 3: Visible wheel components

- |   |               |
|---|---------------|
| 1 | Tyres         |
| 2 | Rim           |
| 3 | Spoke         |
| 4 | Spoke nipples |
| 5 | Hub           |
| 6 | Valve         |

The wheel comprises the *wheel* itself, an inner tube with a valve and a tyre.

##### 3.1.1.1 Valve

Each wheel has a valve. It is used to fill the *tyre* with air. There is a valve cap on each valve. The screw-on valve cap keeps out dust and dirt.

The pedelec has either

- a classic Dunlop valve,
- a French valve (also known as a Sclaverand or Presta valve) or
- a Schrader valve.

#### 3.1.2 Suspension

Both forks and suspension forks are fitted in this model series.

##### 3.1.2.1 Rigid fork

Rigid forks do not feature suspension. They transfer the used muscle and motor power to the road to optimum effect. Pedelecs with rigid forks consume less energy on steep roads and have a greater range than pedelecs with adjusted suspension.

##### 3.1.2.2 Suspension fork

A suspension fork is based either on a steel spring or air suspension.

Unlike a rigid fork, a suspension fork has two functions which improve floor contact and comfort: suspension and damping. The suspension prevents an impact, such as one caused by a stone lying in the pedelec's path, from being channelled directly into the rider's body via the fork. The impact is absorbed by the suspension system instead. This causes the suspension fork to compress.

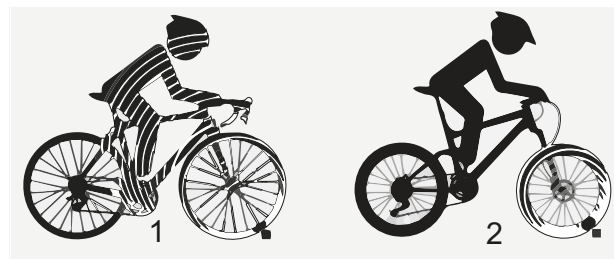

Figure 4: Pedelec without suspension (1) and with suspension (2)

After compressing, the suspension fork returns to its original position. If there is a damper, it decelerates movement, preventing the suspension system from springing back in an uncontrolled manner and stopping the fork from vibrating up and down. Dampers which dampen compressive deflection movements, i.e. a compression load, are called compression dampers or compression dashpots.

Dampers which dampen rebound deflection movements, i.e. a rebound load, are called rebound dampers or dashpots.

The compression can be disabled in any suspension fork. A suspension fork will then behave like a rigid fork.

**Negative deflection**

The negative deflection (sag) is the percentage of total deflection that is compressed by the rider's weight, including equipment (such as a backpack), their seating position and frame geometry. Sag is not caused by riding.

The pedelec rebounds at a controlled speed if it is optimally adjusted. The wheel stays in contact

with the ground when passing over bumps (blue line).

The fork head, handlebars and rider broadly follow the terrain (green line) when riding over bumps. The suspension motion is predictable and controlled.



**Figure 5: Optimum fork riding performance**

When optimally adjusted, the fork counteracts deflection, stays higher in its deflection range and

helps the rider to maintain speed while riding on hilly parts of terrain.

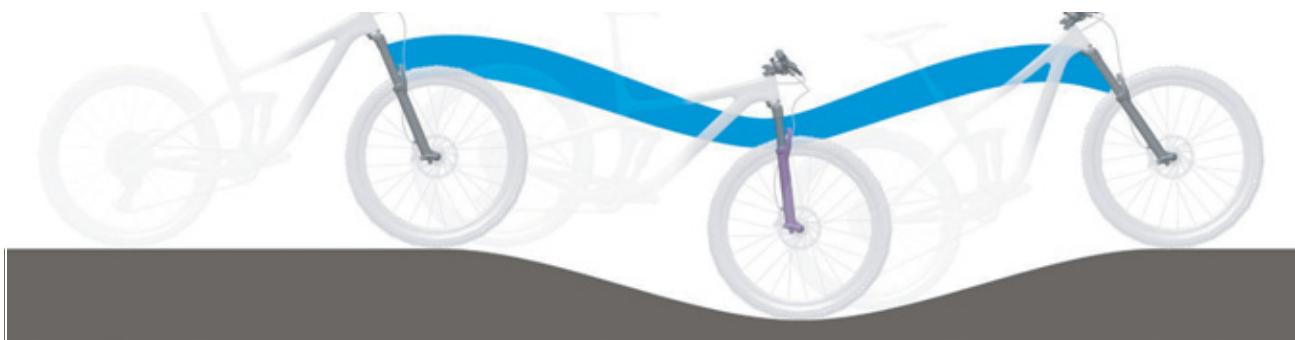

**Figure 6: Optimum fork riding performance on hilly terrain**

When optimally adjusted, the fork deflects quickly and unhindered when the bike hits bumps and absorbs a bump. Traction is retained (blue line).

The fork responds quickly to the bump. The headset and handlebars rise slightly when absorbing a bump (green line).



**Figure 7: Optimum fork riding performance over bumps**



### 3.1.2.3 Steel suspension fork

The stem and handlebars are fastened to the fork steerer. The wheel is fastened to the axle.

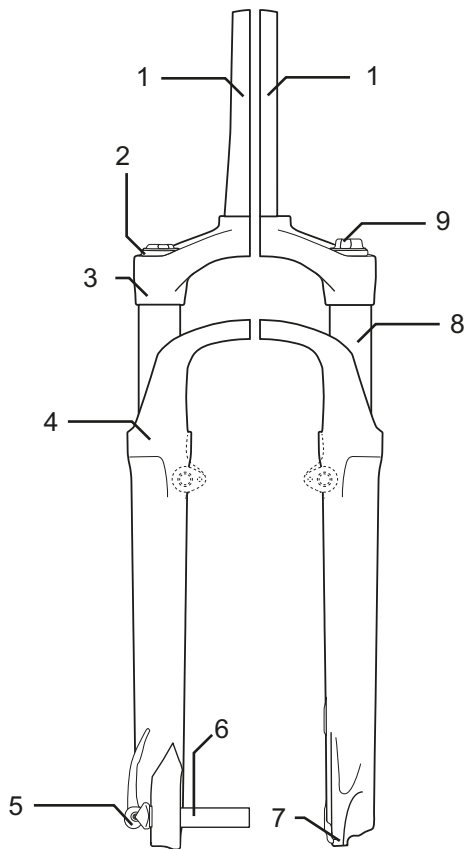

Figure 8: Suntour steel suspension fork as an example

- 1 Fork steerer
- 2 Sag setting wheel
- 3 Crown
- 4 Dust seal
- 5 Q-Loc
- 6 Axle
- 7 Fork end
- 8 Stanchion
- 9 Compression setting

### 3.1.2.4 Air suspension fork

The air suspension fork features an air suspension assembly (orange), a compression damper assembly (blue) and, in some cases, a rebound damper assembly (red).

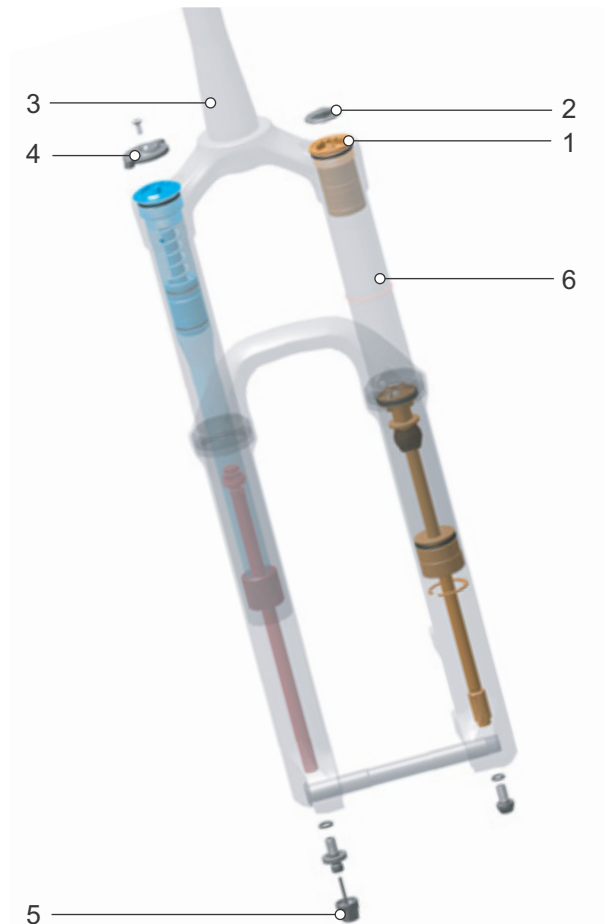

Figure 9: Example showing RockShox Lyrik Select fork

- 1 Air valve
- 2 Air valve cap
- 3 Fork steerer
- 4 Sag setting wheel
- 5 Rebound setting
- 6 Stanchion

### 3.1.3 Brake system

Every pedelec has a hydraulic brake system. The brake fluid is in a closed hose system. If the rider pushes the brake lever, the brake fluid activates the brake on the wheel.

The mechanical brakes are used as an emergency stop system and bring the bicycle to a halt quickly and safely in the event of an emergency.

#### 3.1.3.1 Disc brake

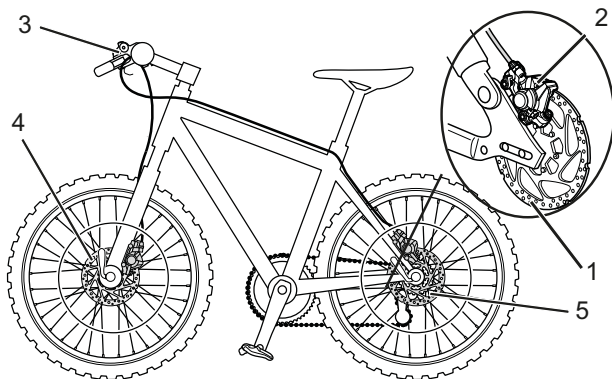

Figure 10: Brake system with disc brake – example

- 1 Brake disc
- 2 Brake calliper with brake linings
- 3 *Handlebars with brake lever*
- 4 Front wheel brake disc
- 5 Rear wheel brake disc

On a pedelec with a disc brake, the brake disc is screwed permanently to the wheel *hub*. The *brake lever* is pushed to increase brake pressure. The brake fluid is used to transfer pressure through the brake cables to the cylinders in the brake calliper. The braking force is boosted by a speed reduction and applied to the brake linings. These apply the brake disc mechanically. If the *brake lever* is pushed, the brake linings are pressed against the brake disc and the wheel movement is decelerated until it comes to a stop.

### 3.1.4 Electric drive system

The pedelec is driven by muscle power applied to the chain drive. The force which is applied by pedalling in the direction of travel drives the front chain wheel. The chain transmits the force onto the rear chain wheel and then onto the rear wheel.

You can ride the pedelec like a normal bike at any time, either by switching off the electric drive system or changing the level of assistance to Off. The same applies when the battery is empty.

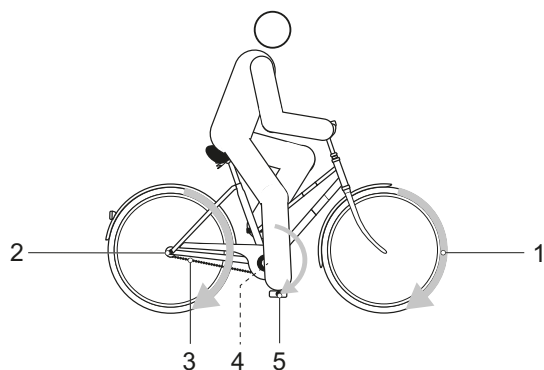

Figure 11: Diagram of drive system

- 1 Direction of travel
- 2 Chain
- 3 Rear chain wheel
- 4 Front chain wheel
- 5 Pedal

The pedelec also has an integrated electric drive system in addition to its drive system propelled by muscle power. The electric drive system is made up of 7 components:

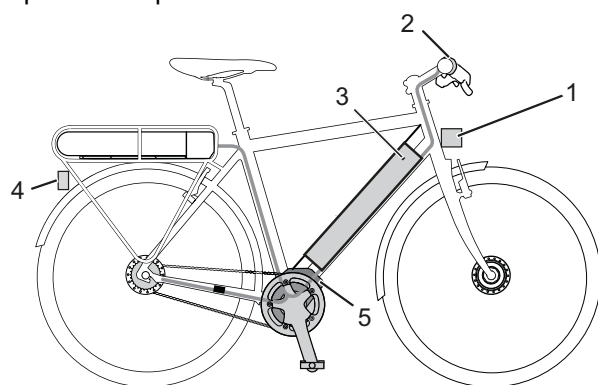

Figure 12: Diagram of electric drive system

- 1 *Headlight*
- 2 *On-board computer/operating element*
- 3 *Rechargeable battery*
- 4 *Rear light*
- 5 *Motor*

#### 3.1.4.1 Motor

As soon as the required muscle power from the rider pedalling passes a certain level, the motor is activated gently and assists the rider's pedalling motion. The motor force is determined by the set level of assistance. The assistance depends on the force applied to the pedals by the rider. Drive system assistance is therefore only activated when the rider pedals. This happens regardless of the selected level of assistance. The motor switches off automatically as soon as the rider no longer pedals, the temperature is outside the permitted range, there is an overload or the shut-off speed of 25 km/h has been reached. If the speed falls below 25 km/h, the assistance is automatically activated again. A push assist system can be activated. The push assist continues to drive the pedelec as long as the rider presses the plus button on the handlebars. The speed can be a maximum of 6 km/h in this case.

#### 3.1.4.2 Rechargeable battery

The lithium ion battery has an internal electronic protection circuit, which is specifically designed for the charger and the pedelec. The battery temperature is monitored at all times. The battery is protected against deep discharge, overcharging, overheating and short circuit. In the event of a hazard, a protective circuit switches the battery off automatically. The battery also switches to sleep mode for self-protection when not used for a longer period. Its battery life can be extended if the battery is well maintained and, more importantly, stored at the correct temperatures. The charging capacity will decrease with age, even if the battery is maintained properly. If the operating time is significantly shortened after charging, this is a sign that the battery has reached the end of its useful life.

The pedelec has an integrated battery.

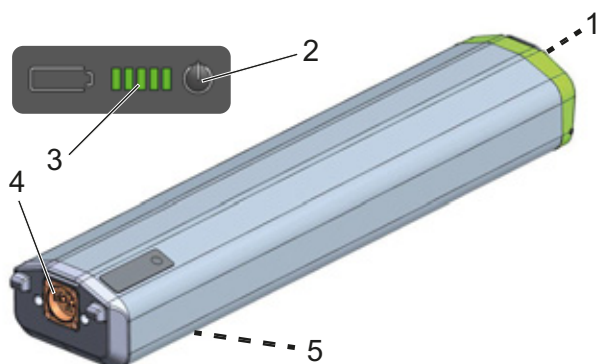

Figure 13: Details of SuperCore rechargeable battery

- 1 Handle lever
- 2 On/off switch
- 3 Battery level indicator
- 4 Charging and discharging socket
- 5 Label on the rear

### 3.1.5 On-board computer

The on-board computer displays the main functions.



Figure 14: Brose Topology on-board computer

#### USB port

There is a USB port under the rubber cover beneath the *on-board computer*. It is not possible to charge external devices via the USB port.

#### 3.1.5.1 Operating element

The control panel on the handlebars uses four buttons to control the on-board computer.

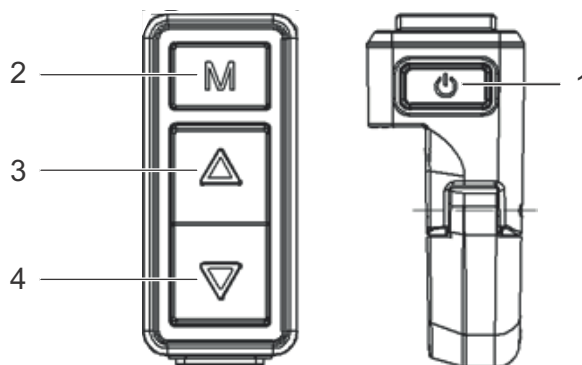

Figure 15: Operating element overview

- 1 On/off switch
- 2 Function button
- 3 Up button
- 4 Down button

### 3.2 Proper use

The pedelec must only be used in perfect, fully functional condition. National requirements may apply to the pedelec which the standard equipment may not meet. For riding on public roads, some special regulations apply in relation to the riding light, reflectors and other components.

The general laws and the regulations for the prevention of accidents and environmental protection in the respective country of use must be adhered to. All check lists and instructions for

actions in these *operating instructions* met. Approved accessories can be installed by specialist staff.

The rechargeable batteries are designed to supply power to the pedelec motor only and must not be used for other purposes.

Each pedelec is assigned a pedelec type, which determines its proper use, function and area of use.







City and trekking bicycles	Child's bicycles/ bicycles for young adults	Mountain bikes	Racing bicycle	Cargo bike	Folding bicycle
					
<p>City and trekking bicycles are designed for daily, comfortable use. They are suitable for riding on public roads.</p>	<p>The legal guardians of minor riders must read and understand these <i>operating instructions</i> before commissioning.</p> <p>The contents of these <i>operating instructions</i> must be communicated to the riders in an age-appropriate manner.</p> <p>The cycles for children and young adults are suitable for riding on public roads. The size of the pedelec must be checked regularly for orthopaedic reasons.</p> <p>A check must be made at least every three months to make sure that the maximum permitted total weight is being observed.</p>	<p>Mountain bikes are designed for sporting use. The design characteristics include a short wheelbase, a sitting position with the rider inclined towards the front, and a brake requiring low actuation force.</p> <p>A mountain bike is a piece of sporting equipment. It requires an adaptation period and the rider must be physically fit. Use requires the appropriate training; in particular riding in bends and braking should be practised.</p> <p>The strain on the rider, in particular the hands and wrists, arms, shoulders, neck and back, is accordingly high. Inexperienced riders tend to brake excessively and lose control as a result.</p>	<p>A racing bicycle is designed for fast rides on roads and paths with a good, undamaged road surface.</p> <p>A racing bicycle is a piece of sporting equipment and not a means of transport. A racing bicycle is characterised by its lightweight structure and a design which is stripped to the minimum parts required for riding.</p> <p>The frame geometry and the layout of the operating elements are designed in such a way that the bicycle can be ridden at high speeds. The frame design requires practice to ensure the ride is able to ride slowly, apply the brakes and get on and off the bike safely.</p> <p>The sitting position is athletic. The strain on the rider, in particular the hands and wrists, arms, shoulders, neck and back, is accordingly high. The sitting position therefore requires physical fitness.</p>	<p>The cargo bike is suitable for daily transportation of loads on public roads.</p> <p>The transportation of loads requires skill and physical fitness in order to balance the additional weight. The very varied loading conditions and weight distributions require special practice and skill when braking and riding in bends.</p> <p>A longer period is required to adapt to the length, width and turning circle. You need to be cautious when riding a cargo bike. You must pay attention to the traffic on public roads and the condition of the route accordingly.</p>	<p>The folding bicycle is suitable for use on public roads.</p> <p>A folding bicycle can be folded up and is thus suitable for space-saving transportation, for example on public transport or in a car.</p> <p>The folding function of the folding bicycle makes it necessary to use smaller wheels and longer brake cables and Bowden cables. Therefore, in case of an increased load, a reduction in riding stability and braking power, diminished comfort and reduced durability are to be expected.</p>

Table 6: Proper use for each pedelec type

### 3.3 Improper use

Failure to adhere to the proper use poses a risk of personal injury and material damage. It is prohibited to use the pedelec in the following ways:

- when the electrical drive system has been manipulated
- riding with a damaged or incomplete pedelec
- riding over steps
- riding through deep water
- charging with an incorrect charger
- lending the pedelec to untrained riders
- carrying other people
- riding with excessive baggage
- riding with no hands
- riding on ice and snow
- improper servicing
- improper repair
- tough areas of use, such as professional competitions
- stunt riding or acrobatics.

City and trekking bicycles	Child's bicycles/ bicycles for young adults	Mountain bikes	Racing bicycle	Cargo bike	Folding bicycle
					
City and trekking bicycles are not sports bicycles. If used for sports, the rider can expect reduced riding stability and diminished comfort.	Cycles for children and young adults are not toys.	Mountain bikes must be retrofitted with lighting, a bell and other fittings as specified by national laws and regulations before they are used on public roads.	Racing bikes must be retrofitted with lighting, a bell and other fittings as specified by national laws and regulations before they are used on public roads.	A cargo bike is not a touring bicycle or a sports bicycle.	The folding bicycle is not a sports bicycle.

Table 7: Information on improper use

### 3.3.1 Maximum permitted total weight

The pedelec may only be loaded to its maximum permitted total weight (PTW). The maximum permitted total weight is the weight of the fully assembled pedelec with the rider and baggage.

Type no.	Model	PTW
21-Q-0023	PASERO PRO I-12	135 kg
21-Q-0024	PASERO PRO I-12	135 kg
21-Q-0025	PASERO PRO I-12	135 kg
21-Q-0026	PASERO COMP I-12	135 kg
21-Q-0027	PASERO COMP I-12	135 kg
21-Q-0028	PASERO COMP I-12	135 kg
21-Q-0029	PASERO COMP I-F5	135 kg
21-Q-0030	PASERO COMP I-F5	135 kg
21-Q-0031	PASERO SPORT I-10	135 kg
21-Q-0032	PASERO SPORT I-10	135 kg
21-Q-0033	PASERO SPORT I-10	135 kg
21-Q-0079	PASERO SUV I-10	135 kg
21-Q-0080	PASERO SUV I-10	135 kg
21-Q-0023	PASERO PRO I-12	135 kg

## 3.4 Technical data

### 3.4.1 Pedelec

Transportation temperature	5 °C - 25 °C
Ideal transportation temperature	10 °C - 15 °C
Storage temperature	5 °C - 25 °C
Ideal storage temperature	10 °C - 15 °C
Operation temperature	5 °C - 35 °C
<i>Work environment</i> temperature	15 °C - 25 °C
Charging temperature	10 °C - 30 °C
Power output/system	250 W (0.25 kW)
Shut-off speed	25 km/h

**Table 8: Pedelec technical data**

### 3.4.2 Brose Drive S motor

Dimensions (mm) (L × W × H)	213 × 150 × 128
Weight	3400 g
Nominal voltage	36 V DC
Protection class	IP56
Max. torque	90 Nm
Continuous power rating	250 W
Assistance up to	25 km/h
Working temperature	-10 - +50 °C

**Table 9: Technical data for Brose Drive S motor**

### 3.4.3 Brose Drive T motor

Dimensions (mm) (L × W × H)	213 × 150 × 128
Weight	3400 g
Nominal voltage	36 V DC
Protection class	IP56
Max. torque	70 Nm
Continuous power rating	250 W
Assistance up to	25 km/h
Working temperature	-10 - +50 °C

**Table 10: Technical data for Brose Drive T motor**

### 3.4.4 Brose Topology on-board computer

<b>Power supply</b>	DC 24V/36V/48V
<b>Rated current</b>	30 ma/36 V
<b>Switch-off point in the event of residual current</b>	<1uA
<b>Display details</b>	3.5", colour, TFT (480× 320 pixels)
<b>Communication</b>	UART (default)
<b>Protection class</b>	IP65
<b>Working temperature</b>	-20 - +60 °C
<b>Storage temperature range</b>	-30 - +80 °C

**Table 11: Technical data for Brose Topology, DS103 on-board computer**

### 3.4.5 SuperCore 750 battery

Nominal capacity	20 Ah
Energy	750 W
Maximum discharging current, continuous	25 A
Maximum charging current, continuous	5 A
Voltage	36 V
Maximum charging voltage	42 V
Weight	3.79 kg
Dimensions in mm (W x H x L)	130 × 60 × 450
Designated charger	Item no. 28555*
Transportation temperature	5 °C - 25 °C
Ideal transportation temperature	10 °C - 15 °C
Storage temperature	5 °C - 25 °C
Ideal storage temperature	10 °C - 15 °C
Charging ambient temperature	10 °C - 30 °C

**Table 12: Technical data for SuperCore 750 battery**

\*Charger: 10S | 45 V | 4.5 A | 100–240 VAC



### 3.4.6 SuperCore 555 battery

Nominal capacity	15 Ah
Energy	555 Wh
Maximum discharging current, continuous	25 A
Maximum charging current, continuous	5 A
Voltage	36 V
Maximum charging voltage	42 V
Weight	3.3 kg
Dimensions in mm (W × H × L)	130 × 60 × 450
Designated charger	Item no. 28555*
Transportation temperature	5 °C - 25 °C
Ideal transportation temperature	10 °C - 15 °C
Storage temperature	5 °C - 25 °C
Ideal storage temperature	10 °C - 15 °C
Charging ambient temperature	10 °C - 30 °C

**Table 13: Technical data for SuperCore 555 battery**

\*Charger: 10S | 45 V | 4.5 A | 100–240 VAC

### 3.4.7 Emissions

A-weighted emission sound pressure level	< 70 dB(A)
Total vibration level for the hands and arms	< 2.5 m/s <sup>2</sup>
Highest effective value of weighted acceleration for the entire body	< 0.5 m/s <sup>2</sup>

**Table 14: Emissions from the pedelec\***

\*The safety requirements as per Electromagnetic Compatibility Directive 2014/30/EU have been met. The pedelec and the charger can be used in residential areas without restriction.

### 3.4.8 Tightening torque

Axle nut tightening torque	35 Nm - 40 Nm
Handlebars clamping screw maximum tightening torque*	5 Nm - 7 Nm

**Table 15: Tightening torque values**

\*if there is no other data on the component

### 3.5 Description of controls and screens

#### 3.5.1 Handlebars



Figure 16: Detailed view of pedelec from rider position, example

- 1 Rear brake lever
- 2 Bell
- 3 Headlight
- 4 Front brake lever
- 5 Gears
- 6 Operating element
- 7 On-board computer
- 8 Fork lock
- 9 Gears

#### 3.5.2 On-board computer

The *on-board computer* features a display screen.

##### 3.5.2.1 <Home screen>

The <Home screen> on the on-board computer has up to eight indicators:

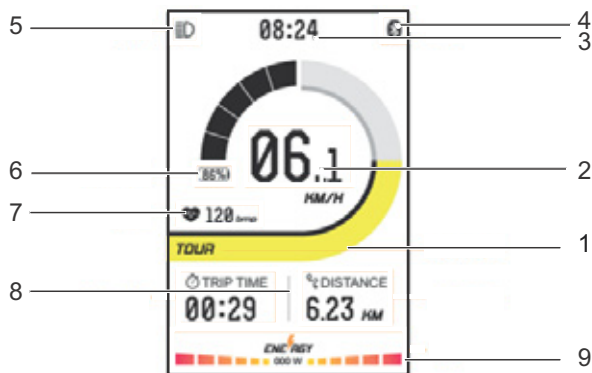

Figure 17: Overview of <Home screen>

- 1 Level of assistance indicator
- 2 Current speed indicator
- 3 Clock indicator
- 5 Riding light indicator
- 6 Battery level indicator
- 7 Pulse indicator
- 8 Journey information indicator
- 9 Motor power output screen

#### 1 Level of assistance indicator

The higher a level of assistance, the more the drive system assists the rider when pedalling. The following levels of assistance are available.

Symbol	Designation	Area of use
	OFF	Riding without motor assistance
	ECO	Low assistance for maximum battery life. Best assistance when starting up.
	TOUR	Continuous assistance, suitable for long distances with a long battery life.
	SPORT	Sports riding for medium to short trip distances.
	TURBO	High level of assistance on inclines or short distances on urban roads.

Table 16: Overview of levels of assistance

#### 2 Current speed indicator

You can select whether the speed is displayed in kilometres or miles in the system settings.

#### 3 Clock indicator

The clock is displayed in a 24-hour format.

#### 5 Riding light indicator

 The riding light symbol is shown when the riding light is on.

### 6 Battery level indicator (on-board computer)

The battery level indicator consists of 5 segments.

If the battery level is less than 5 %, the battery icon turns yellow and starts to flash. The battery level indicator starts flashing.

	Charging
	0 - 5 %
	5 - 39 %
	40 - 59 %
	60 - 70 %
	70 - 90 %
	90 - 100 %

Table 17: Indicator for battery level in on-board computer

### 7 Pulse indicator

The pulse symbol is displayed if the pulse monitor is switched on and networked.

### 8 Journey information indicator

The function display shows three different items of information:

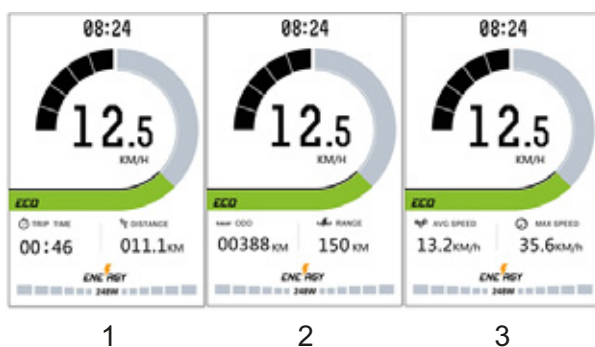

Figure 18: Journey information indicator

- 1 Trip time      Trip time
- 2 ODO            Total kilometres
- 3 AVG Speed    Average speed

The displayed journey information can be switched.

### 9 Motor power indicator

The motor power is displayed using six bars

	Charging
	0 %
	< 50 W
	< 100 W
	< 150 W
	< 200 W
	< 250 W
	< 340 W

Table 18: Motor power indicator

### 3.5.2.2 <Set screen>

The <Set screen> is used to adjust system settings.

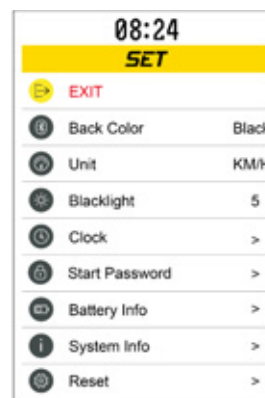

Figure 19: <Set screen>

To see the system settings, the rider needs to access the system settings. The rider can change the values of the system settings.

Designation	Function
BACK COLOR	Setting background colour
UNIT	Setting units
BACKLIGHT	Adjusts the backlight
CLOCK	Setting the clock
SET PASSWORD	Changing the password
BATTERY INFO	Display battery information
SYSTEM INFO	Display system information
RESET	Reset to factory setting

Table 19: List of system settings

### 3.5.2.3 Daytime and night mode

When the riding light is activated, the *headlight* and the rear light are switched on. When the riding light is activated, the display screen switches from daytime to night mode.

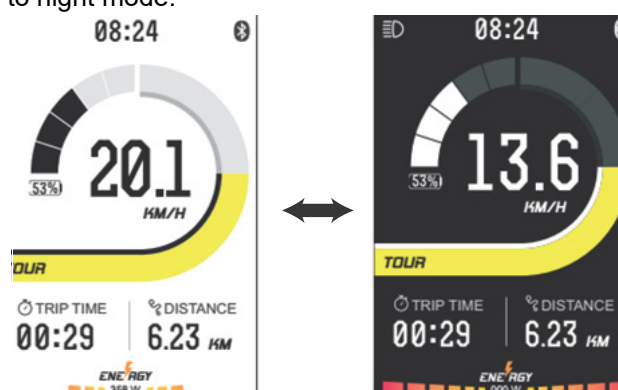

Figure 20: Daytime and night mode

### 3.5.2.4 System message

The drive system monitors itself continuously and shows a system message on the display screen in the case of a known error. The system may switch off automatically depending on the type of error.

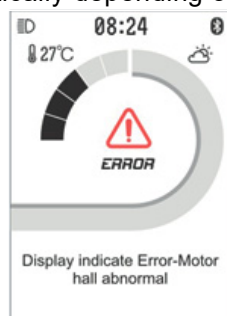

Figure 21: Example of an error message

There is a table of all system messages in Section 6.2.

### 3.5.3 Battery level indicator (rechargeable battery)

The battery indicator is on the battery:

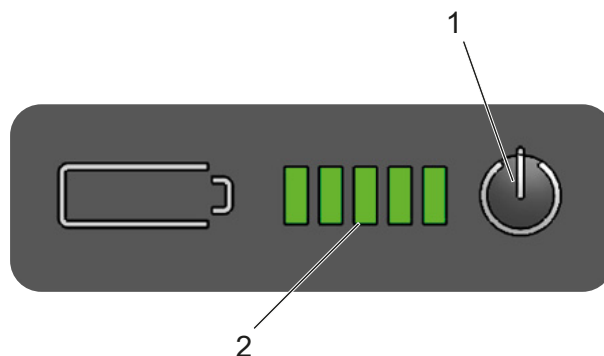

Figure 22: Overview of battery level indicator on rechargeable battery

- 1 On-Off button (battery)
- 2 Battery level indicator

Symbol	Meaning
●	LED on
○	LED off
★	LED flashing

Table 20: Battery level indicator

The battery level is displayed if you press the **on-off button (battery)** briefly.

LED 1,2,3,4,5	Battery level
● ● ● ● ●	100 - 80 %
● ● ● ● ○	79 - 60 %
● ● ● ○ ○	59 - 40 %
● ● ○ ○ ○	39 - 20 %
● ○ ○ ○ ○	19 - 10 %
★ ○ ○ ○ ○	9 - 0 %

Table 21: Battery level indicator on rechargeable battery

### 3.6 Environmental requirements

You can be ride the pedelec within a temperature range between 5 °C and 35 °C. The electric drive system is limited in its performance outside this temperature range.

<b>Optimal operating temperature</b>	22 °C - 26 °C
--------------------------------------	---------------

**Table 22: Optimum temperatures**

During winter use, especially at temperatures below 0 °C, we recommend that you don't insert a battery charged and stored at room temperature into the pedelec until just before setting off. We recommend using thermal protection sleeves when riding longer distances in the cold.











Temperatures under -10 °C and over +40 °C must be avoided.

You must also keep within the following temperature ranges:

Transportation temperature	10 °C - 40 °C
Storage temperature	10 °C - 40 °C
Work environment temperature	15 °C - 25 °C
Charging temperature	10 °C - 40 °C











**Table 23: Pedelec technical data**

The nameplate contains symbols for the pedelec's area of use. Check what roads and paths you may use before you ride the bicycle for the first time.

Area of use	City and trekking bicycles	Child's bicycles/ bicycles for young adults	Mountain bikes	Racing bicycle	Cargo bike	Folding bicycle
 <b>1</b>	 Suitable for tarmacked and paved roads.	 Suitable for tarmacked and paved roads.		 Suitable for tarmacked and paved roads.	 Suitable for tarmacked and paved roads.	 Suitable for tarmacked and paved roads.
 <b>2</b>	Suitable for tarmacked roads, cycle paths and firm gravel paths and roads, and longer sections with moderate slopes and jumps up to 15 cm.	Suitable for tarmacked roads, cycle paths and firm gravel paths and roads, and longer sections with moderate slopes and jumps up to 15 cm.	Suitable for tarmacked roads, cycle paths and firm gravel paths and roads, and longer sections with moderate slopes and jumps up to 15 cm.	Suitable for tarmacked roads, cycle paths and firm gravel paths and roads, and longer sections with moderate slopes and jumps up to 15 cm.		
 <b>3</b>			Suitable for tarmacked roads, cycle paths and easy to demanding off-road riding, sections with moderate slopes and jumps up to 61 cm.			
 <b>4</b>			Suitable for tarmacked roads, cycle paths and easy to demanding off-road riding, limited downhill use and jumps up to 122 cm.			

**Table 24: Area of use**

The pedelec is unsuitable for the following areas of use:

Area of use	City and trekking bicycles	Child's bicycles/ bicycles for young adults	Mountain bikes	Racing bicycle	Cargo bike	Folding bicycle
 <b>1</b>	 Never drive off-road or perform jumps.	 Never drive off-road or perform jumps.		 Never drive off-road or perform jumps.	 Never drive off-road or perform jumps.	 Never drive off-road or perform jumps.
 <b>2</b>	Never drive off-road or perform jumps over 15 cm.	Never drive off-road or perform jumps over 15 cm.	Never drive off-road or perform jumps over 15 cm.	Never drive off-road or perform jumps over 15 cm.		
 <b>3</b>			Never ride downhill or perform jumps over 61 cm.			
 <b>4</b>			Never traverse extremely difficult off-road terrain or perform jumps over 122 cm.			

## 4 Transportation and storing

### 4.1 Physical transport characteristics

Weight and dimensions during transportation

Type no.	Frame	Box dim. [cm]	Weight** [kg]	Shipping weight [kg]
21-Q-0023	53 cm	t.b.a.	t.b.a.	t.b.a.
	57 cm	t.b.a.	t.b.a.	t.b.a.
	61 cm	t.b.a.	t.b.a.	t.b.a.
21-Q-0024	45 cm	t.b.a.	t.b.a.	t.b.a.
	49 cm	t.b.a.	t.b.a.	t.b.a.
	53 cm	t.b.a.	t.b.a.	t.b.a.
	57 cm	t.b.a.	t.b.a.	t.b.a.
21-Q-0025	53 cm	t.b.a.	t.b.a.	t.b.a.
	57 cm	t.b.a.	t.b.a.	t.b.a.
	61 cm	t.b.a.	t.b.a.	t.b.a.
21-Q-0026	45 cm	t.b.a.	t.b.a.	t.b.a.
	49 cm	t.b.a.	t.b.a.	t.b.a.
	53 cm	t.b.a.	t.b.a.	t.b.a.
21-Q-0027	45 cm	t.b.a.	t.b.a.	t.b.a.
	49 cm	t.b.a.	t.b.a.	t.b.a.
	53 cm	t.b.a.	t.b.a.	t.b.a.
	57 cm			
21-Q-0028	53 cm	t.b.a.	t.b.a.	t.b.a.
	57 cm	t.b.a.	t.b.a.	t.b.a.
	61 cm	t.b.a.	t.b.a.	t.b.a.
21-Q-0029	53 cm	t.b.a.	t.b.a.	t.b.a.
	57 cm	t.b.a.	t.b.a.	t.b.a.
	61 cm	t.b.a.	t.b.a.	t.b.a.
21-Q-0030	53 cm	t.b.a.	t.b.a.	t.b.a.
	57 cm	t.b.a.	t.b.a.	t.b.a.
	61 cm	t.b.a.	t.b.a.	t.b.a.
21-Q-0031	53 cm	t.b.a.	t.b.a.	t.b.a.
	57 cm	t.b.a.	t.b.a.	t.b.a.
	61 cm	t.b.a.	t.b.a.	t.b.a.

Table 25: Type number, model and pedelec type

Type no.	Frame	Box dim. [cm]	Weight** [kg]	Shipping weight [kg]
21-Q-0032	53 cm	t.b.a.	t.b.a.	t.b.a.
	57 cm	t.b.a.	t.b.a.	t.b.a.
	61 cm	t.b.a.	t.b.a.	t.b.a.
21-Q-0033	53 cm	t.b.a.	t.b.a.	t.b.a.
	57 cm	t.b.a.	t.b.a.	t.b.a.
	61 cm	t.b.a.	t.b.a.	t.b.a.
21-Q-0079	53 cm	t.b.a.	t.b.a.	t.b.a.
	57 cm	t.b.a.	t.b.a.	t.b.a.
	61 cm	t.b.a.	t.b.a.	t.b.a.
21-Q-0080	53 cm	t.b.a.	t.b.a.	t.b.a.
	57 cm	t.b.a.	t.b.a.	t.b.a.
	61 cm	t.b.a.	t.b.a.	t.b.a.

Table 25: Type number, model and pedelec type

\* Vehicle weight without battery. The vehicle's total weight depends on the battery used.

Battery type	Weight
UltraCore 750 battery	3.79 kg
UltraCore 555 battery	3.3 kg

### 4.2 Designated handles/lifting points

The box does not have any handles.

## 4.3 Transportation



### Crash caused by unintentional activation

There is a risk of injury if the drive system is activated unintentionally.

- ▶ Remove the battery.

### 4.3.1 Using the brake transport securing system

Applicable for pedelec disc brakes only



### Oil leak if no transport securing device

The brake securing device prevents the brakes from being applied accidentally during transportation or shipment. This could cause irreparable damage to the brake system or an oil leak, which will harm the environment.

- ▶ Never push the brake lever when the wheel has been dismantled.
  - ▶ Always use the transport securing system when transporting or shipping.
- 
- ▶ Insert the **transport securing devices** between the brake linings.
- ⇒ Transport securing device is squeezed between the two linings and prevents undesired sustained braking which can cause brake fluid to leak out.

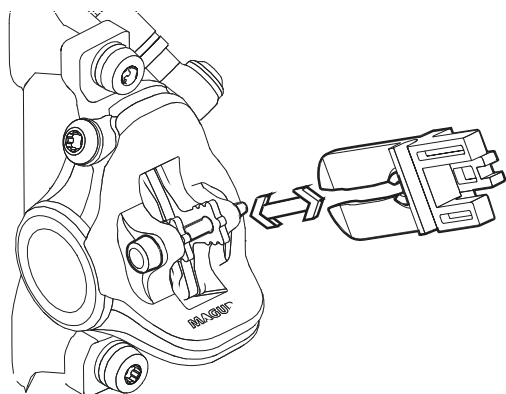

Figure 23: Fastening the transport securing device

### 4.3.2 Transporting the pedelec

Bicycle racks which use the handlebars or frame to hold the pedelec in an upside-down position exert inadmissible forces on its components during transportation. This can cause the supporting parts to break.

- ▶ Never use bicycle racks which use the pedelec's handlebars or frame to hold it in an upside-down position. The specialist dealer will advise you on how to select a suitable rack system properly and how to use it safely.
- ▶ Take into account the weight of the ready-to-use pedelec when transporting it.
- ▶ Protect the electrical components and connections on the pedelec from the weather conditions with suitable protective covers.
- ▶ Transport the battery in a dry, clean position where it is protected from direct sunlight.

### 4.3.3 Shipping a pedelec

- ▶ When shipping the pedelec, we recommend that you have the specialist dealer partially dismantle the pedelec and place it in the proper packaging.

### 4.3.4 Transporting the battery

*Batteries* are subject to hazardous goods regulations. Undamaged batteries may be transported by private persons in road traffic.

Commercial transport requires compliance with regulations concerning packaging, labelling and the transportation of hazardous goods. Open contacts must be covered and the battery securely packaged.

### 4.3.5 Shipping the battery

The battery is considered a hazardous good and only trained persons may pack and ship a battery. Contact your specialist dealer.



## 4.4 Storing



### Accident after storage

The brake system is not designed for use on a pedelec which is placed on its side or turned upside down. The brake may not function correctly as a result. This can cause a crash, which may result in injuries.

- ▶ If the pedelec is placed on its side or turned upside down, apply the brake a couple of times before setting off to ensure that it works as normal.

- ▶ Store pedelec, on-board computer, battery and charger in a clean, dry place where they are protected from sunlight. Do not store outdoors to ensure a long service life.

Optimum pedelec storage temperature	10 °C - 20 °C
-------------------------------------	---------------

**Table 26: Storage temperature for batteries and the pedelec**

- ✓ Temperatures under -10 °C or over +40 °C must generally be avoided.
- ✓ Storage at about 10 °C to 20 °C is beneficial to a long battery life.
- ✓ Store pedelec, on-board computer, battery and charger separately.

### 4.4.1 Storage mode

The on-board computer features a power-saving storage mode, which minimises discharge from the on-board computer battery. The date and time are eliminated during storage mode.

#### 4.4.1.1 Activating

The display will no longer start up when you press the **on-off button (on-board computer)** briefly once in storage mode.

- ▶ Press and hold the **On-Off button (on-board computer)** for at least 8 seconds.
- ⇒ Storage mode is activated if the on-board computer does not start after the **On-Off button (on-board computer)** is pressed briefly.

#### 4.4.1.2 Deactivating

- ▶ Press and hold the **On-Off button (on-board computer)** for at least 2 seconds.
- ⇒ Storage mode is deactivated.

## 4.4.2 Break in operation

### Notice

The battery discharges when not in use. This can cause irreparable damage to the battery.

- ▶ The battery must be recharged every 6 months.

The battery may become damaged if it is connected permanently to the charger.

- ▶ Never connect the battery to the charger permanently.

The on-board computer battery discharges when it is not in use. This can cause irreparable damage to the on-board computer.

- ▶ The battery must be recharged every 3 months.

- ▶ Remove the on-board computer from its mount if the pedelec is not going to be used for four weeks. Store the on-board computer away safely in a dry environment at room temperature.

- ▶ If the pedelec is removed from service for longer than four weeks, you need to prepare it for a break in operation.

#### 4.4.2.1 Preparing a break in operation

- ✓ Remove the rechargeable battery from the pedelec.
- ✓ Charge battery to around 30 % - 60 %.
- ✓ The pedelec needs to be cleaned with a damp cloth and preserved with wax spray. Never wax the friction surfaces of the brake.
- ✓ Before longer periods without use, it is recommendable to have your specialist dealer carry out an inspection and basic cleaning and apply preservative agent.

#### 4.4.2.2 Carrying out a break in operation

- 1 Store the pedelec, battery and charger in a dry, clean environment. We recommend storing them in uninhabited rooms with smoke alarms. Dry locations with an ambient temperature of about 10 °C to 20 °C are ideal.
- 2 Recharge the on-board computer battery for at least 1 hour every 3 months.
- 3 Check the battery level after 6 months. If only one LED on the battery level indicator lights up, recharge the battery to around 30 % - 60 %.



## 5 Assembly

### WARNING

#### Risk of eye injury

Problems may arise if the settings are not made to components correctly and you may sustain serious injuries as a result.

- ▶ Always wear safety glasses to protect your eyes during assembly.

### CAUTION

#### Crash and crushing hazard caused by unintentional activation

There is a risk of injury if the drive system is activated unintentionally.

- ▶ Remove the battery.

- ✓ Assemble the pedelec in a clean, dry environment.
- ✓ The *work environment* temperature should be between 15 °C and 25 °C.
- ✓ The fitting stand used must be approved for a maximum weight of at least 30 kg.

### 5.1 Required tools

The following tools are required to assemble the pedelec:

- Knife
- Hexagon socket spanner 2 (2.5 mm, 3 mm, 4 mm, 5 mm, 6 mm and 8 mm)
- Torque wrench with working range between 5 and 40 Nm
- Twelve-point square socket T25
- Ring spanner (8 mm, 9 mm, 10 mm), 13 mm, 14 mm and 15 mm) and
- Cross, flat head and ordinary screwdriver.

## 5.2 Unpacking

The packaging material consists mainly of cardboard and plastic film.

- ▶ The packaging has to be disposed of in accordance with the regulations of the authorities.

### 5.2.1 Scope of delivery

Pedelects are fully assembled in the factory for test purposes and then dismantled for transportation.

The pedelec is 95 - 98 % pre-assembled. The scope of delivery includes:

- the pre-assembled pedelec
- the front wheel
- the pedals
- quick release (optional)
- the charger
- the *operating instructions*.

The battery is supplied separately from the pedelec.

## 5.3 Commissioning

### CAUTION

#### Burns from hot drive

The drive cooler can become extremely hot during use. Touching it may cause burns.

- ▶ Leave the drive unit to cool before assembly.

Only trained specialist staff may perform initial commissioning since initial commissioning of the pedelec requires special tools and specialist knowledge.

Experience has shown that a pedelec which has not yet been sold is automatically handed to customers as soon as it appears ready to ride.

- ▶ Complete an assembly report for quality assurance.
- ▶ The assembly report (see Section [11.2](#)) describes all safety-relevant inspections, tests and maintenance tasks for the pedelec in a separate list. All assembly work must be completed to ensure the pedelec is ready to ride.

## 5.4 Preparing the battery

### 5.4.1 Checking the battery

The battery must be checked before it is charged for the first time.

#### 1 Press the **On-Off button (battery)**.

- ⇒ If none of the LEDs on the battery level indicator light up, the battery may be damaged.
- ⇒ The battery may be fully charged if at least one, but not all, of the LEDs on the battery level indicator is lit up.

### 5.4.2 Retrofitting the battery locking lever

The battery locking lever can be retrofitted to SuperCore or UltraCore batteries if they do not have one.

#### 5.4.2.1 Preparing the frame

- 1 Cut out the drilling template in Section 11.4 along the blue dotted line.

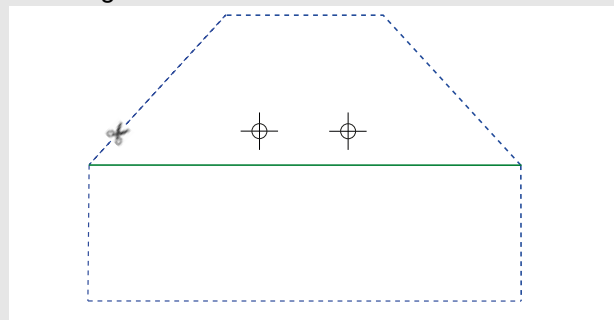

Figure 24: Cutting out along the blue line

- 2 Fold drilling template along green dotted line.

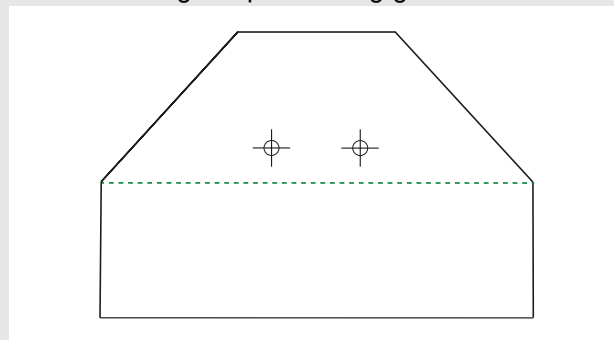

Figure 25: Folding along the green line (line 1)

- 3 Place and position drilling template on frame.
- 4 Stick drilling template to frame.
- 5 Make hole mark.
- 6 Pre-drill hole 3.3 mm in diameter (M4).
- 7 Cut M4 thread.

### 5.4.2.2 Fitting the locking lever

- 1 Insert the countersunk screws (1) into the base plate (2).

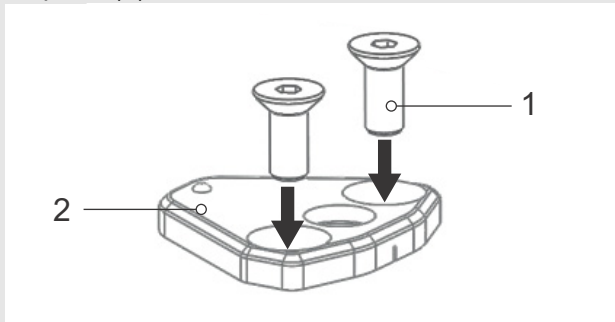

Figure 26: Inserting countersunk screws into base plate

- 2 Join the locking lever to the base plate using the chainring screws. Use a thread locker.

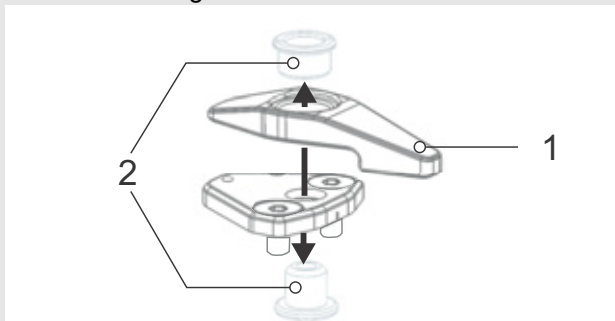

Figure 27: Joining the locking lever with the base plate

- 3 Fasten countersunk screws into the frame using a M4 Allen key. Use a thread locker.

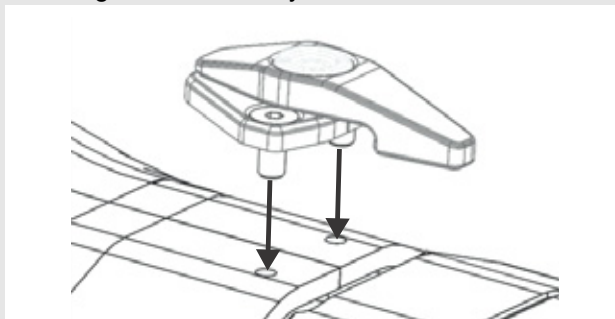

Figure 28: Screwing lever to frame

### 5.4.3 Installing the wheel in the Suntour fork

- 1 Before installing, ensure that the quick release flange is extended. Open the lever fully.

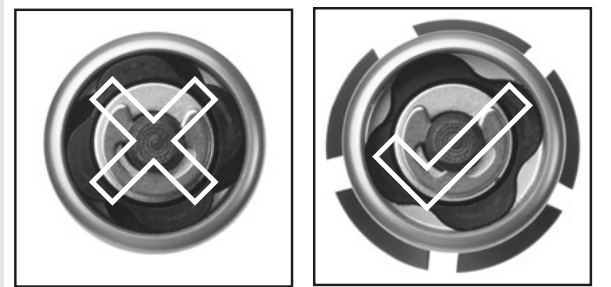

Figure 29: Open and closed flange

- 2 Push in the quick release until you can hear a click. Make sure that the flange is extended.



Figure 30: Pushing the quick release in

- 3 Adjust tensioning with half-open clamping lever until the flange reaches the fork end.

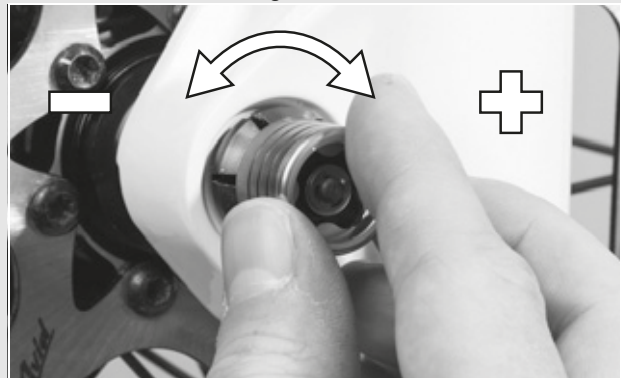

Figure 31: Adjusting the clamping

- 4 Fully close the quick release. Check that the quick release is firmly in place and adjust it on the flange if necessary.

⇒ The lever is secured.



Figure 32: Closing the quick release

## 5.4.4 Checking the stem and handlebars

### 5.4.4.1 Checking the connections

- 1 Stand in front of the pedelec to check whether the handlebars, stem and fork steerer are firmly attached to one another. Clamp the front wheel between your legs. Grasp the handlebar grips.
- 2 Try to twist the handlebars towards the front wheel.

⇒ The stem must not move or twist.

### 5.4.4.2 Firm hold

- 1 Place your entire body weight on the handlebars with the quick release lever closed to check that the stem is firmly in place.
- ⇒ The handlebars shaft must not move downwards in the fork steerer.
- 2 If the handlebars shaft should move in the fork steerer, increase the quick release lever tensioning. To do so, turn the knurled nut slightly clockwise with the quick release lever open.
  - 3 Close the lever and check the stem is firmly in position.

### 5.4.4.3 Checking the headset backlash

- 1 To check the handlebar headset backlash, close the quick release lever on the stem.
- 2 Place the fingers of one hand on the upper headset cup. Pull the front wheel brake with the other hand and try to push the pedelec backwards and forwards.
- 3 The headset cup halves must not move towards one another while you are doing this. Note that there may be noticeable backlash due to worn-out bearing bushes or brake lining backlash in suspension forks and disc brakes.
- 4 If there is headset backlash in the steering headset, you must adjust it as soon as possible; otherwise, the headset will become damaged. You must make the adjustment as described in the stem manual.

## 5.5 Pedelec sale

- ▶ Complete Pedelec pass on the operating instructions envelope.
- ▶ Note down the manufacturer and the number of the battery key.
- ▶ Adjust the pedelec to the rider; see Section 6.5.
- ▶ Set the stand and shifter.
- ▶ Instruct the operator or rider on how to use all the pedelec's functions.

## 6 Operation

### 6.1 Risks and hazards

#### WARNING

#### Injuries and death caused by other road users

Other road users, trucks, cars or pedestrians often underestimate the speed of pedelecs. Likewise, other road users frequently do not see pedelecs. This may cause a crash with serious injuries or even death.

- ▶ Wear a cycling helmet and high-visibility, reflective clothing.
- ▶ Always take a defensive approach to riding.
- ▶ Avoid the blind spots of vehicles turning off. Reduce speed as a precaution when other road users turn right.

#### Injuries and death caused by riding incorrectly

A pedelec is not a bicycle. Incorrect riding and underestimated speeds soon result in hazardous situations. This may cause a fall with serious injuries or even death.

- ▶ If you haven't ridden on a pedelec for some time, get accustomed to the speed first before you ride at speeds over 12 km/h. Increase the levels of assistance gradually.
- ▶ Practice braking hard on a regular basis.
- ▶ Take and complete a riding safety course.

#### Injuries and death caused by distraction

A lack of concentration while riding increases the risk of an accident. This may cause a crash with serious injuries.

- ▶ Never allow yourself to be distracted by the display or your mobile phone.
- ▶ Stop bicycle if you want to make inputs on the display other than a change in level of assistance. Only enter data when the bicycle is stationary

#### CAUTION

#### Crash caused by loose clothing

Shoe laces, scarves and other loose items may become entangled in the spokes on the *wheels* and on the *chain drive*. This may cause a crash with injuries.

- ▶ Wear sturdy footwear and close-fitting clothing.

#### Crash caused by difficult-to-spot damage

If the pedelec topples over or you have a fall or an accident, there may be difficult-to-spot damage to components such as the brake system, quick releases or *frame*. This may cause a crash with injuries.

- ▶ Take the pedelec out of service and have a specialist dealer carry out an inspection.

#### Crash caused by material fatigue

Intensive use can cause material fatigue. A component may suddenly fail in case of material fatigue. This may cause a crash with injuries.

- ▶ Remove the pedelec from service immediately if there are any signs of material fatigue. Have the specialist dealer check the state.
- ▶ Have the specialist dealer carry out a basic inspection regularly. During the inspection, the specialist dealer will inspect the pedelec for any signs of material fatigue on the frame, fork, suspension element mountings (if there are any) and components made of composite materials.

Carbon becomes brittle when exposed to heat radiation such as heating. This can cause the carbon part to break and result in a crash with injuries.

- ▶ Never expose carbon parts on the pedelec to strong sources of heat.

**CAUTION**
**Crash caused by poor road conditions**

Loose objects, such as branches and twigs, may become caught in the wheels and cause a crash with injuries.

- ▶ Be aware of the road conditions.
- ▶ Ride slowly and brake in good time.

The *tyres* may slip on wet roads. In wet conditions you must also expect a longer braking distance. The braking sensation differs from the usual sensation. This can cause loss of control or a crash, which may result in injuries.

- ▶ Ride slowly and brake in good time when it is raining.

**Crash caused by soiling**

Heavy soiling can impair pedelec functions, such as braking. This may cause a crash with injuries.

- ▶ Remove coarse soiling before riding.

**Notice**

Heat or direct sunlight can cause the *tyre pressure* to increase above the permitted maximum pressure. This can destroy the *tyres*.

- ▶ Never park the pedelec in the sun.
- ▶ On hot days, regularly check the *tyre pressure* and adjust it as necessary.

When riding downhill, high speeds may be reached. The pedelec is only designed to exceed a speed of 25 km/h for short intervals. The *tyres* in particular can fail if exposed to a continuous load.

- ▶ Use the brakes to decelerate the pedelec if you reach speeds greater than 25 km/h.

**Notice**

Moisture penetrating at low temperatures may impair individual functions due to the open structural design.

- ▶ Always keep the pedelec dry and free from frost.
- ▶ If the pedelec is to be used at temperatures below 3 °C, the specialist dealer must carry out an inspection and prepare it for winter use.

Off-road riding subjects the joints in the arms to severe strain. Take a break from riding every 30 to 90 minutes, depending on the road surface conditions and your physical fitness

**6.2 Personal protective equipment**

It is recommended that you wear a suitable cycling helmet, sturdy footwear and typical, close-fitting, reflective sports clothing.

## 6.3 Tips for a greater range

The pedelec's range depends on many influencing factors. A single battery charge may only last fewer than 20 kilometres but much more than 100 is also possible. There are a few tips which will generally help you maximize range.

### Suspension elements

- ▶ Only open suspension fork and damper when necessary on terrain or gravel paths. Block suspension fork and damper on tarmacked roads or on hills.

### Peddalling frequency

- ▶ Ride using pedalling frequencies of over 50 revolutions per minute. This optimises the electric drive's efficiency.
- ▶ Avoid pedalling very slowly.

### Weight

- ▶ Minimise the total weight of pedelec and baggage.

### Stopping and starting

- ▶ Ride long distances at a constant speed.
- ▶ Avoid stopping and starting frequently.

### Level of assistance

- ▶ The higher the selected level of assistance, the lower the range.

### Gear shift

- ▶ Use a low gear and a low level of assistance on hills and when setting off.
- ▶ Switch up a gear depending on the speed and terrain.
- ▶ 50-80 crank rotations are optimal.
- ▶ Avoid high stress loads on the crank during a gear change.
- ▶ Switch gear back in good time, e.g. before inclines.

### Tyres

- ▶ Always select the right tyres for the surface type.
- ▶ Always use the maximum permitted tyre pressure.

### Rechargeable battery

Electrical resistance increases as the temperature drops. Battery performance is reduced. As a result, you should expect the range to be shorter than normal in winter.

- ▶ Use a thermal protection sleeve on the battery in winter.

The range also depends on the battery's age, charge level and state of repair.

- ▶ Maintain the battery and replace older batteries where necessary.



## 6.4 Error messages

### 6.4.1 Error message display

Parts of the electronic drive system are permanently monitored during use and charging. If an error is detected, the error code detected appears on the display screen.

Press any button on the control panel to switch the display screen back to the default screen.

Code	Description	Method of resolution
10	Low battery voltage (<27 V)	► Charge battery with battery charger.
11	Excess battery voltage (> 45 V)	1 Re-start the system. 2 Contact your specialist dealer if the problem persists.
12	Battery discharge detected	► Charge the battery.
20	ADC test failed	1 Re-start the system. 2 Contact your specialist dealer if the problem persists.
21	Unlikely temperature detected by the upper side sensors	1 Re-start the system. 2 Contact your specialist dealer if the problem persists.
23	Unlikely temperature detected by the lower side sensors	1 Re-start the system. 2 Contact your specialist dealer if the problem persists.
24	Voltage drop of 12 V detected (<11 V)	► Charging the battery
25	Excess current in motor (>24 A)	1 Re-start the system. 2 Contact your specialist dealer if the problem persists.
26	Reset detected in two unknown systems	1 Re-start the system. 2 Contact your specialist dealer if the problem persists.
30	Communication error	1 Re-start the system. 2 Contact your specialist dealer if the problem persists.
31	Light: Low output voltage/fault detected	► Check cables and connectors on all the electric drive system components.

**Table 27: List of display screen error messages**

Code	Description	Method of resolution
40	The measured current exceeds the maximum permitted level (20 A)	► Reduce the load on the motor by pedalling less or reducing the levels of assistance.
41	Hardware overcurrent protection active	► Reduce the load on the motor by pedalling less or reducing the levels of assistance.
42	Error detected in the angled sensor	1 Re-start the system. 2 Contact your specialist dealer if the problem persists.
43	The measured current does not fall beneath the max. permitted value (2 A) after motor assistance	1 Re-start the system. 2 Contact your specialist dealer if the problem persists.
44	Max. temperature exceeded	► Reduce the load on the motor by pedalling less or reducing the levels of assistance.
45	Angled sensor reset detected	1 Re-start the system. 2 Contact your specialist dealer if the problem persists.
46	No motor movement detected, although current measured (>2 A)	1 Re-start the system. 2 Contact your specialist dealer if the problem persists.
60	HMI CAN timeout message detected	► Check cables and connectors on all the electric drive system components.
70	Torque sensor reading outside the permitted range ([230 ... 450 HZ])	1 Re-start the system. 2 Contact your specialist dealer if the problem persists.
71	Pedalling rate sensor short circuit	1 Re-start the system. 2 Contact your specialist dealer if the problem persists.
72	No signal from the torque sensor	1 Re-start the system. 2 Contact your specialist dealer if the problem persists.

**Table 27: List of display screen error messages**

Code	Description	Method of resolution
73	The difference in torque between two measurements exceeds the permitted value ( $\pm 166$ )	1 Re-start the system. 2 Contact your specialist dealer if the problem persists.
74	RAM test failed	1 Re-start the system. 2 Contact your specialist dealer if the problem persists.
75	Invalid pedal sensor signal detected	1 Re-start the system. 2 Contact your specialist dealer if the problem persists.
76	12 V out excess current	1 Re-start the system. 2 Contact your specialist dealer if the problem persists.
80	No offset angle calibration carried out (EOL)	1 Re-start the system. 2 Contact your specialist dealer if the problem persists.
81	No interruption in the speed sensor detected	1 Re-start the system. 2 Contact your specialist dealer if the problem persists.
82	ROM test failed	1 Re-start the system. 2 Contact your specialist dealer if the problem persists.
83	Stack test failed	1 Re-start the system. 2 Contact your specialist dealer if the problem persists.
84	No serial number detected	1 Re-start the system. 2 Contact your specialist dealer if the problem persists.
85	Accelerator handle CAN timeout message detected.	► Check cables and connectors on all the electric drive system components.
86	Accelerator handle voltage outside the permitted range ([0.5 V ... 4.2 V])	1 Re-start the system. 2 Contact your specialist dealer if the problem persists.
87	Accelerator handle has not yet reached off position (torque requirement: zero) (~0.5 V)	1 Re-start the system. 2 Contact your specialist dealer if the problem persists.

**Table 27: List of display screen error messages**

Code	Description	Method of resolution
90	Error detected in the program start-up.	1 Re-start the system. 2 Contact your specialist dealer if the problem persists.
91 92 93	The torque sensor has transmitted incorrect data	1 Re-start the system. 2 Contact your specialist dealer if the problem persists.
94	The high-side drive has detected an error (excess current or temperature)	1 Re-start the system. 2 Contact your specialist dealer if the problem persists.
95	Brake light current detected (>0.3 A)	► Check cables and connectors on all the electric drive system components.

**Table 27: List of display screen error messages**

## 6.5 Instruction and customer service

Your supplying specialist dealer will provide customer service. Contact details can be found on the pedelec pass for these operating instructions. The specialist dealer will explain all the pedelec functions to you in person, this being when the specialist dealer hands over the pedelec at the latest. These operating instructions are provided to you with every pedelec, so that you can consult them at a later stage.

Your specialist dealer will also be happy to assist you in the future whether you require maintenance, conversion or repair.

## 6.6 Adjusting the pedelec



### Crash caused by incorrectly adjusted torques

If a screw is fastened too tightly, it may break. If a screw is not fastened enough, it may loosen. This will cause a crash with injuries.

- ▶ Always observe the indicated torques on the screw and in the *operating instructions*.

Only a correctly adjusted pedelec will guarantee the desired ride comfort and health-promoting activity. Therefore adjust the *saddle*, the *handlebars* and the *suspension* to your body and your preferred riding style before the first ride.

### 6.6.1 Adjusting the saddle

#### 6.6.1.1 Adjusting the saddle tilt

The saddle tilt must be adjusted to the seat height, the saddle and handlebar position, and the saddle shape to ensure an optimum fit. The seating position can be optimised in this way if needed. First adjust the handlebars, then the saddle.

- ▶ Adjust the saddle tilt to horizontal.

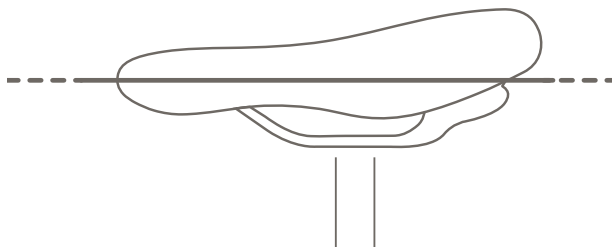

Figure 33: Horizontal saddle tilt

#### 6.6.1.2 Determining the seat height

- ✓ To adjust the seat height safely, either
    - push the bike near to a wall, so that the rider can lean on the wall to support themselves or
    - ask another person to hold the pedelec.
- 1 Climb onto the bicycle.
  - 2 Place your heel on the pedal and extend your leg, so that the pedal is at the lowest crank rotation point.
- ⇒ The rider sits straight on the saddle if the seat is at an optimum height. If this is not the case, adjust the length of the seat post to your needs.

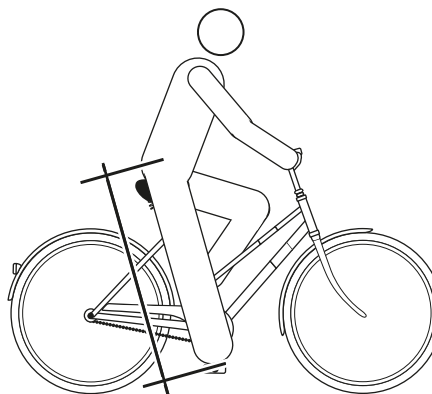

Figure 34: Optimal saddle height

### 6.6.1.3 Adjusting the seat height with quick release

- 1 Open the quick release on the seat post to change the seat height (1). To do so, push the clamping lever away from the seat post (3).

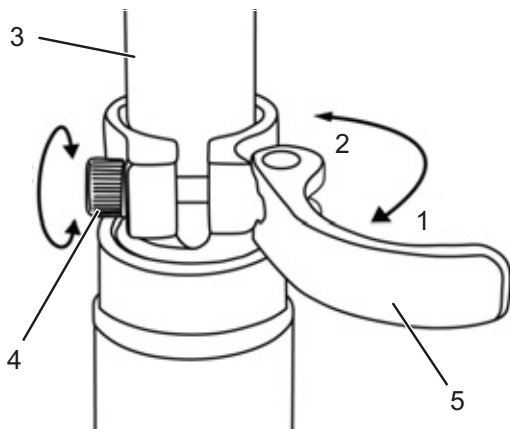

Figure 35: Opening the seat post quick release

- 2 Set the seat post to the required height.



#### Crash caused by an excessively high seat post setting

A seat post with is set too high will cause the seat post or the frame to break. This will cause a crash with injuries.

- ▶ Do not pull the seat post out of the frame beyond the minimum insertion depth marking.

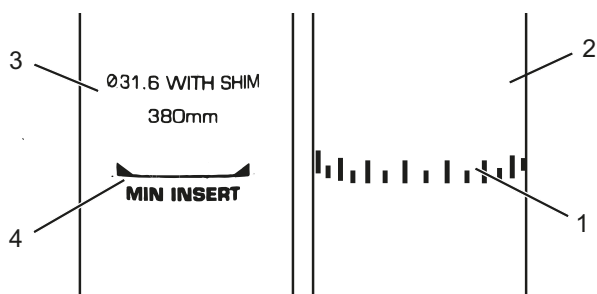

Figure 36: Detailed view of the seat post – examples of the minimum insertion depth marking

- 3 To close it, push the seat post clamping lever as far as it will go into the seat post (2).
- 4 Check the clamping force of quick releases.

### 6.6.1.4 Adjusting the seat position

The saddle can be shifted on the saddle frame. The right horizontal position ensures an optimal leverage position for legs. This prevents knee pain and painful incorrect pelvis positions. If you have displaced the saddle more than 10 mm, you need to adjust the saddle height again since both settings affect one another.

- ✓ To adjust the seat position safely, either push the pedelec near to a wall, so that you can lean on the wall to support yourself or ask another person to hold the pedelec for you.

- 1 Climb onto the bicycle.
- 2 Place the pedals into the vertical position with your feet.

The rider is sitting in the optimal sitting position if the perpendicular line from the kneecap runs through the pedal axle.

- 3.1 If the perpendicular line crosses behind the pedal, bring the saddle further forward.
- 3.2 If the perpendicular line crosses in front of the pedal, bring the saddle further back.
- 4 Move the saddle within its permitted displacement range only (marked on the saddle stay).

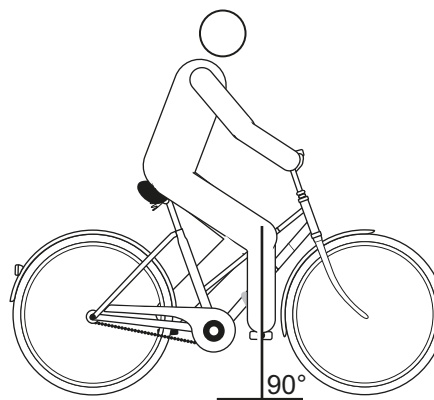

Figure 37: Knee cap perpendicular line

- ✓ The handlebar settings must only be adjusted while the bicycle is stationary.
- ▶ Unfasten and adjust the designated screw connections, and clamp them with the maximum tightening torque for the clamping screws of the handlebars.

## 6.6.2 Adjusting the handlebars

### CAUTION

#### Crash caused by incorrectly set clamping force

Excessively high clamping force will damage the quick release and cause it to lose its function. Insufficient clamping force will result in unfavourable transmission of force. This can cause components to break. This will cause a crash with injuries.

- ▶ Never fasten a quick release using a tool (e.g. hammer or pliers).
- ▶ Only use the clamping lever with the specified set clamping force.

## 6.6.3 Adjusting the stem

### CAUTION

#### Crash caused by loose stem

Incorrectly fastened screws may come loose due to impact. The stem may no longer be firmly fixed in its position as a result. This will cause a crash with injuries.

- ▶ Check the handlebars and the quick release system are firmly in position after the first two hours of riding.

### 6.6.3.1 Adjusting the height of the handlebars

- 1 Open the stem clamping lever.

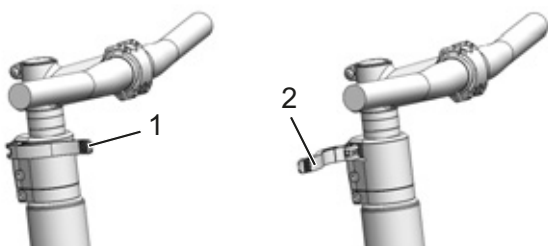

Figure 38: Open (2) and closed (1) stem clamping lever; All Up used as an example

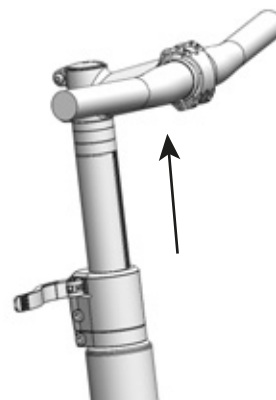

Figure 39: Pulling the locking lever upwards; All Up used as an example

- 2 Pull out the handlebars to the required height. Observe minimum insertion depth.
- 3 Close the stem clamping lever.

### 6.6.3.2 Adjusting the quick release clamping force

- ▶ If the *handlebar clamping lever* stops before reaching its end position, unscrew the *knurled nut*.
- ▶ Tighten the *knurled nut* on the seat post if the *seat post clamping lever's* clamping force is not effective enough.
- ▶ If you are unable to set the clamping force, the specialist dealer will need to check the quick release.

## 6.6.4 Adjusting the brake

The brake lever grip distance can be adjusted to ensure that it can be reached more easily. The pressure point can also be adjusted to the rider's preferences.

Contact your specialist dealer if there is no description of your brake below.

### 6.6.4.1 Retracting the brake linings

Disc brakes require wearing-in time. The braking force increases over time. You therefore need to be aware that the braking force may increase during the wearing-in period. The same happens after brake pads or discs are replaced.

- 1 Accelerate pedelec to about 25 km/h.
- 2 Brake pedelec until it comes to a halt.
- 3 Repeat process 30–50 times.

The disc brake is retracted and provides optimal braking power.

### 6.6.5 Adjusting the damping sag



#### Crash caused by incorrectly set suspension

If the suspension is set incorrectly, the fork may become damaged, meaning problems may occur when steering. This will cause a crash with injuries.

- ▶ Never ride the bicycle without air in the air suspension fork.
- ▶ Never use the pedelec without adjusting the suspension fork to the rider's weight.

#### Notice

Settings on the chassis change riding performance significantly. You need to get used to the bicycle and break it in to prevent accidents.

The negative deflection (sag) is the percentage of total deflection that is compressed by the rider's weight, including equipment (such as a backpack), their seating position and frame geometry. Sag is not caused by riding.

The sag depends on the rider's position and weight and should be between 15% and 30% of the maximum fork deflection, depending on preferences and on how the pedelec is used.

#### Greater sag (20% to 30%)

A greater sag increases sensitivity to bumps, thus producing greater suspension motion. A greater sensitivity to bumps ensures more comfortable ride performance and is used on bicycles with a longer deflection.

#### Decreased sag (10% to 20%)

A decreased sag reduces sensitivity to bumps, thus producing less suspension motion. A lower sensitivity to bumps ensures a firmer, more efficient ride and is generally used on bicycles with a longer deflection.

The adjustment shown here represents a basic setting. The rider should change the basic setting to suit the surface and his/her preferences.

It is advisable to make a note of the basic setting. This way, it can be used as the starting point for subsequent, optimised settings and to safeguard against unintentional changes.

#### 6.6.5.1 Adjusting the Suntour fork steel suspension

**Only applies to pedelecs with this equipment**

- 1 You will find the **sag setting wheel** beneath the plastic cover on the crown. Remove the plastic cover.



Figure 40: Sag setting wheel on the suspension fork crown

- ▶ Turn the **sag setting wheel** clockwise to increase the spring pre-tensioning.
- ▶ Turn the **sag setting wheel** anti-clockwise to decrease the spring pre-tensioning.
- ⇒ You will have made the ideal setting if the shock absorber deflects 3 mm when bearing the rider's weight.
- 3 Replace the plastic cover on the crown after making the setting.

### 6.6.5.2 Adjusting the Suntour fork air suspension

Only applies to pedelecs with this equipment

- ▶ The **air valve** is located beneath the **air valve cap** on the crown. Twist off the **air valve cap**.



Figure 41: Screw caps in different designs

- 1 Attach a high-pressure damper pump to the **air valve**.
- 2 Pump air suspension fork to the required pressure. Observe the levels in the Suntour filling pressure table. Never exceed the recommended maximum air pressure.

Rider weight	AION, NEX	XCR 32, XCR 34
< 55 kg	35 - 50 psi	40 - 55 psi
55 - 65 kg	50 - 60 psi	55 - 65 psi
65 - 75 g	60 - 70 psi	65 - 75 psi
75 - 85 kg	70 - 85 psi	75 - 85 psi
85 - 95 kg	85 - 100 psi	85 - 95 psi
< 100 kg	+ 105 psi	+ 100 psi
<b>Maximum air pressure</b>	<b>150 psi</b>	<b>180 psi</b>

Table 28: Suntour filling pressure table for air forks

- 3 Detach high-pressure damper pump.
- 4 Measure the distance between the crown and the dust seal. This distance is *total deflection* of the fork.
- 5 Push a temporarily attached cable tie downward against the dust seal.
- 6 Put on your normal cycling clothing, including luggage.
- 7 Sit on the pedelec in your usual riding position and support yourself against an object, such as a wall or tree.
- 8 Get off the pedelec without allowing it to deflect.
- 9 Measure distance between the dust seal and the cable tie.
- ⇒ This measurement is the sag. The recommended value is between 15% (hard) and 30% (soft) of the total fork deflection.
- 10 Increase or reduce air pressure until you have reached the desired sag.
- 11 If the sag is correct, turn the **air valve cap** clockwise.
- 12 If you are unable to achieve the required sag, an internal adjustment may be needed. Contact your specialist dealer.

### 6.6.6 Adjusting the rebound damping

Rebound damping in the suspension fork and the rear frame damper determines the speed at which the rear frame damper rebounds after being subjected to load. Rebound damping controls the suspension fork extension and rebound speed, which, in turn, has an impact on traction and control.

Rebound damping can be adjusted to the rider's weight, spring stiffness, deflection, the terrain and the rider's preferences.

If the air pressure or spring stiffness increases, the extension and rebound speeds also increase. Rebound damping may need to be increased to achieve an optimal setting if the air pressure or spring stiffness are increased.

The damper rebounds at a controlled speed if the fork is optimally adjusted. The wheel stays in contact with the ground when passing over bumps (blue line).

The fork head, handlebars and rider broadly follow the terrain (green line) when riding over bumps. The suspension motion is predictable and controlled.

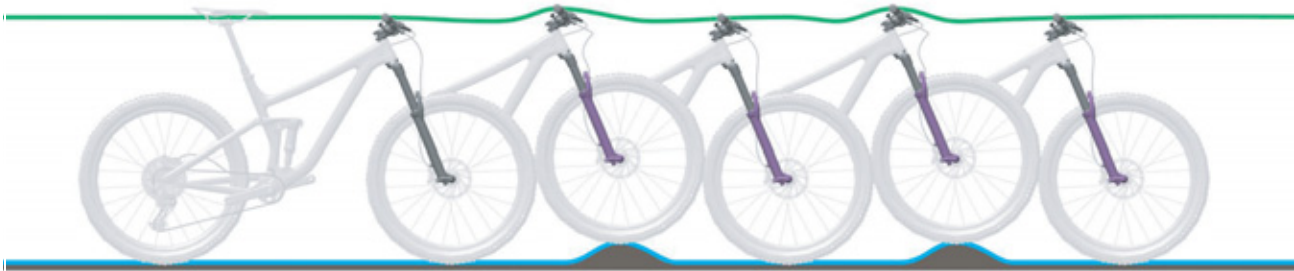

Figure 42: Optimum fork riding performance



### 6.6.6.1 Adjusting the Suntour air suspension fork

Only applies to pedelecs with this equipment

- 1 Turn the **Suntour rebound screw** in a clockwise direction to the closed position until it stops.

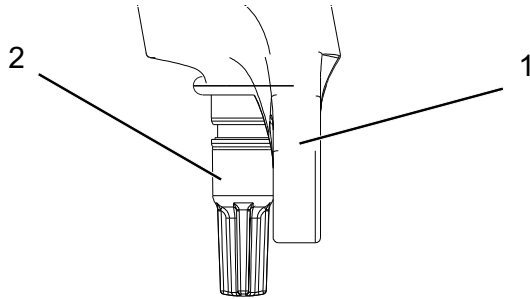

Figure 43: Suntour rebound screw (2), fork (1)

- 2 Turn the **Suntour rebound screw** slightly in an anti-clockwise direction.
- 3 Adjust the rebound in such a way that the fork rebounds quickly, but without bottoming out upward. Bottoming out refers to when the fork rebounds too quickly and stops moving abruptly once it has reached the full rebound distance. You can hear and feel a slight impact when this happens.

## 6.7 Accessories

We recommend a parking stand into which either the front wheel or rear wheel can be inserted securely for pedelecs which do not have a kickstand. The following accessories are recommended:

Description	Article number
Protective cover for electrical components	080-41000 ff
Panniers, system component*	080-40946
Rear wheel basket, system component*	051-20603
Bicycle box, system component*	080-40947
Parking stand universal stand	XX-TWO14B

Table 29: Accessories

\*System components are matched to the pannier rack and provide sufficient stability due to special transmission of force.

\*\*System components are matched to the drive system.

### 6.7.1 Child seat

#### WARNING

##### Crash caused by incorrect child seat

The pannier rack and down tube are unsuitable for mounting child seats and may break. Such an incorrect position may cause a crash with serious injuries for the rider and the child.

- ▶ Never attach a child seat to the saddle, handlebars or down tube.

#### CAUTION

##### Crash caused by improper handling

When using child seats, the pedelec's handling characteristics and stability change considerably. This can cause a loss of control, a crash and injuries.

- ▶ You should practice how to use the child seat safely before using the pedelec in public spaces.

#### CAUTION

##### Risk of crushing due to exposed springs

The child may crush his/her fingers on exposed springs or open mechanical parts of the saddle and the seat post.

- ▶ Never install saddles with exposed springs if a child seat is being used.
- ▶ Never install seat posts with suspension with open mechanical parts and exposed springs if a child seat is being used.

#### Notice

- ▶ Observe the legal regulations on the use of child seats.
- ▶ Observe the operating and safety instructions for the child seat system.
- ▶ Never exceed the maximum permitted total weight.

The specialist dealer will advise you on choosing a suitable child seat system for the child and the pedelec.

The specialist dealer must install the child seat the first time to ensure that it is safely fitted.

When installing a child seat, the specialist dealer makes sure that the seat and the fastening mechanism for the seat are suitable for the pedelec and that all components are installed and firmly fastened. They will also ensure that shift cables, brake cables, hydraulic lines and electrical cables are adjusted as necessary, the rider has optimum freedom of movement and the pedelec's maximum permitted total weight is complied with.

The specialist dealer will provide instruction on how to handle the pedelec and the child seat.

## 6.7.2 Trailer



### Crash caused by brake failure

The braking distance may be longer if the trailer is carrying excessive load. The long braking distance can cause a crash or an accident and injuries.

- ▶ Never exceed the specified trailer load.

### Notice

- ▶ The operating and safety instructions for the trailer system must be observed.
- ▶ The statutory regulations on the use of bicycle trailers must be observed.
- ▶ Only use type-approved coupling systems.

A pedelec which is approved for towing a trailer will bear an appropriate adhesive label. You may only use trailers with a tongue load and weight which do not exceed the permitted values.

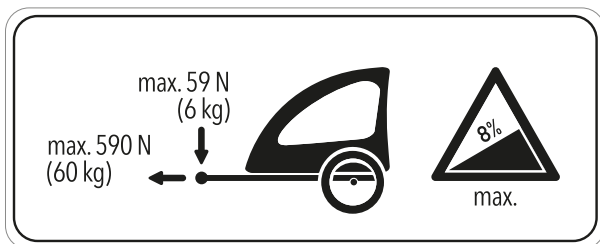

Figure 44: Trailer sign

The specialist dealer will advise on choosing a suitable trailer system for the pedelec. The specialist dealer must install the trailer the first time to ensure that it is safely fitted.

### 6.7.2.1 Trailer approval for Enviolo hub gear

Only compatible bicycle trailers are approved for Enviolo hub gears.

#### KETTLER

KETTLER Quadriga child trailer

#### Burley

Trailer	Adapter
Minnow Bee	Item no. 960038
Honey Bee	
Encore	
solo	
Cub	
D'Lite	
Normad	
Flatbed	
Tail Wagon	

#### Croozer

Trailer	Adapter
Croozer Kid	Item no. 122003516, XL: +10 mm Item no. 122003716 Item no. 12200715 Croozer axle nut adapter with Thule coupling
Croozer Kid Plus	
Croozer Cargo	
Croozer Dog	

#### Thule

Trailer	Adapter
Thule Chariot Lite	Item no. 20100798
Thule Chariot Cab	
Thule Chariot Cross	
Thule Chariot Sport	
Thule Coaster XT	

### 6.7.3 Pannier rack

The specialist dealer will advise on choosing a suitable pannier rack.

The specialist dealer must install the pannier rack the first time to ensure that it is safely fitted.

When installing a pannier rack, the specialist dealer makes sure that the fastening mechanism is suitable for the pedelec and that all components are installed and firmly fastened. They will also ensure that shift cables, brake cables, hydraulic lines and electrical cables are adjusted as necessary, the rider has optimum freedom of movement and the pedelec's maximum permitted total weight is not exceeded.

The specialist dealer will provide instruction on how to handle the pedelec and the pannier rack.

### 6.7.4 Mobile holder

#### Only applies to pedelecs with this equipment

A holder for SP Connect mobile case is fitted to the stem.

- ✓ Observe the operating instructions for the mobile and the SP Connect mobile case.
- ✓ Use on tarmacked roads only.
- ✓ Protect mobile from theft.
- ▶ To attach: insert the SP Connect mobile case in the holder and turn 90° to the right.
- ▶ To release: turn the SP Connect mobile case 90° to the left and remove.

### 6.7.5 Suspension fork coil spring

If the desired suspension fork sag cannot be achieved after adjustment, the coil spring assembly must be replaced with a softer or harder spring.

A softer coil spring assembly must be installed to increase the sag.

A harder coil spring assembly must be installed to decrease the sag.

### 6.7.6 Tubeless and airless

Riding a bike without tyre tubes reduces the risk of tyre punctures and even avoids them completely.

The specialist dealer will advise you on choosing a suitable tyre system for the pedelec.

The conversion to tubeless or airless tyres must be carried out by a specialist dealer to ensure the safety.

## 6.8 Check list before each ride

► Check the pedelec before each ride.

⇒ Take the pedelec out of service if you spot any anomalies.

<input type="checkbox"/>	Check that the pedelec is complete.
<input type="checkbox"/>	Check the battery is firmly in place.
<input type="checkbox"/>	Check that the lighting, reflector and brake, for instance, are sufficiently clean.
<input type="checkbox"/>	You must check that the mudguards, the pannier rack and the chain guard are securely installed.
<input type="checkbox"/>	Check that the front and rear wheels run true. This is particularly important if the pedelec been transported or secured with a lock.
<input type="checkbox"/>	Check the valves and the tyre pressure. Adjust as necessary before each ride.
<input type="checkbox"/>	If the bicycle has a hydraulic rim brake, check whether the locking levers are fully closed in their final positions.
<input type="checkbox"/>	Check the front and rear wheel brakes to make sure that they are working properly. To do so, push the brake levers while stationary to check whether resistance is generated in the usual brake lever position. The brake must not lose any brake fluid.
<input type="checkbox"/>	Check that the riding light is working.
<input type="checkbox"/>	Check for unusual noises, vibrations, smells, staining, deformation, cracks, scores, abrasion and wear. This indicates material fatigue.
<input type="checkbox"/>	Inspect suspension system for cracks, dents, bumps, parts or leaking oil. Look at concealed sections on the pedelec's lower surface.
<input type="checkbox"/>	If quick releases are used check them to make sure that they are fully closed in their end position.
<input type="checkbox"/>	Be alert to any unusual operating sensations when braking, pedalling or steering.

## 6.9 Raising the kickstand

- ▶ Use your foot to raise the kickstand completely before setting off.

## 6.10 Using the pannier rack



### Crash caused by loaded pannier rack

The pedelec is handled differently with a loaded *pannier rack*, in particular when the rider needs to steer and brake. This can lead to a loss of control. This may cause a crash with injuries.

- ▶ You should practice how to use a loaded *pannier rack* safely before using the pedelec in public spaces.

### Crushing the fingers in the spring flap

The spring flap on the *pannier rack* operates with a high clamping force. There is a risk of crushing the fingers.

- ▶ Never allow the spring flap to snap shut in an uncontrolled manner.
- ▶ Be careful where you position your fingers when closing the spring flap.

### Crash caused by unsecured baggage

Loose or unsecured objects on the *pannier rack*, e.g. belts, may become caught in the rear wheel. This may cause a crash with injuries.

Objects which are fastened to the *pannier rack* may cover the *reflectors* and the *riding light*. Other users may not see the pedelec on public roads as a result. This may cause a crash with injuries.

- ▶ Secure any objects which are attached to the *pannier rack* sufficiently.
- ▶ Objects fastened to the *pannier rack* must never cover the *reflectors*, the *headlight* or the *rear light*.

- ▶ Distribute the baggage as evenly as possible between the left- and right-hand side.
- ▶ We recommend the use of panniers and baggage baskets.

The maximum load bearing capacity is indicated on the *pannier rack*.

- ▶ Never exceed the maximum permitted *total weight* when packing the pannier.
- ▶ Never exceed the maximum load bearing capacity of the pannier rack.
- ▶ Never modify the pannier rack.

## 6.11 Using the saddle

- ▶ Do not wear studded jeans as these can damage the saddle covering.
- ▶ Wear dark clothes for your first few rides as new leather saddles can stain clothing.

## 6.12 Rechargeable battery

- ✓ Switch off the battery and the drive system before removing or inserting the battery.

### 6.12.1 Removing the battery

- 1 Turn locking lever to left.

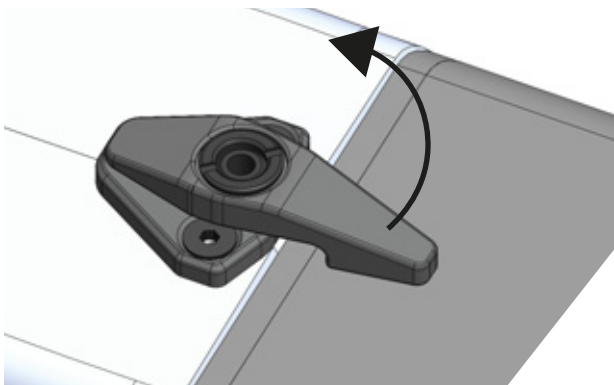

Figure 45: Opening the locking lever

- 2 Use your right hand to push the battery up into the frame.
  - ⇒ The lock hook is disengaged in the frame.
- 3 Hold underneath the battery with your right hand. Press key towards the down tube.
  - ⇒ The lock hook releases the battery.
- 4 The battery will now fall out of the frame or can be pulled out of the down tube, depending on how much space there is between the battery and down tube.
- 5 Remove the key from the lock.

### 6.12.2 Inserting the battery

- 1 Place the battery into the lower mount with the contacts facing the front.
- 2 Open the lock with the key.
- 3 Press the key towards the down tube and hold.
  - ⇒ The lock hook in the frame clears the way for the battery.
- 4 Swivel the battery into the down tube. Apply a little pressure to push the battery into the frame.
- 5 Release the key.
- 6 The lock hook moves into the secure position and holds the battery.
- 7 Close the lock. Remove the key.
- 8 Turn locking lever to right.

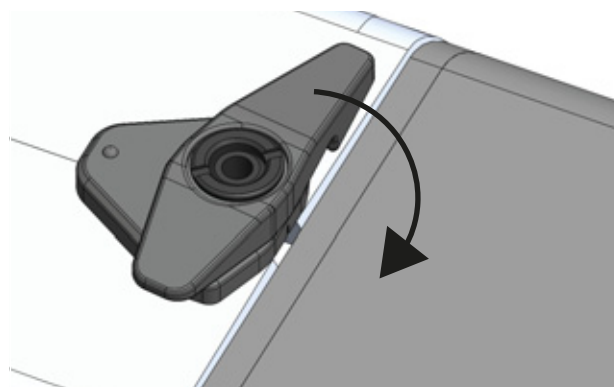

Figure 46: Closing the locking lever

- 9 Check the battery is firmly in position.

### 6.12.3 Charging the battery

- ▶ If an error occurs during the charging process, a system message is displayed. Remove the charger and battery from operation immediately and follow the instructions.
  - ✓ Contact your specialist dealer if you are unable to recharge the battery or it is damaged.
  - ✓ The battery can remain on the pedelec or can be removed for charging.
  - ▶ Remove the rubber cover from the battery.
  - ▶ Connect the mains plug of the charger to a normal domestic, grounded socket.
  - ▶ Connect the charging cable to the battery's charging port. Only use the charger supplied in the scope of delivery.
- ⇒ The charging process starts automatically.

The indicator shows the charge level during charging.

LED 1,2,3,4,5	Battery level
● ● ● ● ●	100 - 80 %
● ● ● ● ○	79 - 60 %
● ● ● ○ ○	59 - 40 %
● ● ○ ○ ○	39 - 20 %
● ○ ○ ○ ○	19 - 10 %
★ ○ ○ ○ ○	9 - 0 %

Table 30: Battery level indicator on rechargeable battery

When the drive system is switched on, the *display screen* shows the charging process.







Symbol	Charging
 12	0 - 5 %
 12	5 - 39 %
 12	40 - 59 %
 12	60 - 70 %
 12	70 - 90 %
 12	90 - 100 %

Table 31: Indicator for battery level in on-board computer

⇒ The charging process is complete when the LEDs on the battery level indicator go out.

### 6.12.4 Waking the battery

- ✓ When not used for a longer period, the battery switches to sleep mode for self-protection. The LEDs on the battery level indicator do not light up.
- ▶ Press the **On-Off button (battery)**.
- ▶ The battery level indicator shows the charge level.



## 6.13 Electric drive system

### 6.13.1 Switching on the electric drive system



#### Crash caused by lack of readiness for braking

When it is switched on, the drive system can be activated by the application of force on the pedals. There is a risk of a crash if the drive is activated unintentionally and the brake is not reached.

- ▶ Never start the electric drive system, or switch it off immediately, if the brake cannot be reached safely and reliably.

- ✓ A sufficiently charged battery has been inserted into the pedevec.
- ✓ The battery is firmly positioned. The key has been removed.

- ▶ Press the **On-Off button (operating element)**.

or

- ▶ Press the **On-Off button (battery)** briefly.

⇒ The indicator will switch on after a few seconds.

⇒ If the drive system is switched on, the drive is activated as soon as the pedals are moved with sufficient force.

### 6.13.2 Switching off the drive system

The system switches off automatically several minutes after the last command. The following options are available to manually switch off the drive system:

- ▶ Press the **On-Off button (operating element)**.

or

- ▶ Press the **On-Off button (battery)** for a long time.

⇒ The display and LEDs on the battery level indicator will go out.

## 6.14 On-board computer

### Notice

- ▶ Never use the on-board computer as a handle. The on-board computer may become irreparably damaged if you use it to lift the pedelec.

The control panel on the handlebars uses four buttons to control the on-board computer.

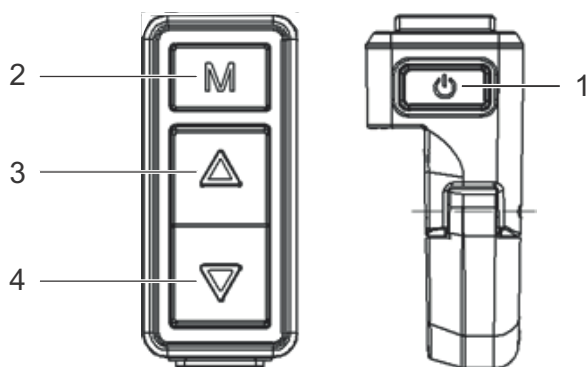

Figure 47: Overview of control panel

- 1 On-Off button (control panel)
- 2 Function button
- 3 Up button
- 4 Down button

### 6.14.1 Switching the on-board computer on

- 1 Press and hold the **On-Off button (control panel)** for about 2 seconds.
  - ⇒ The electric drive system is switched on.
  - ⇒ A prompt will appear asking you to enter the PIN.

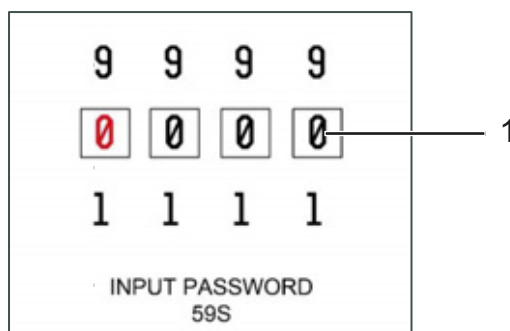

Figure 48: Overview of control panel

- 2 Press the **function button** briefly.
- 3 Press the **up button** or **down button** briefly to **enter** the PIN.

**The initial PIN is 0000.**

- 4 Press the **function button** briefly.
  - ⇒ The <Home screen> appears.
  - ⇒ If the PIN is incorrect, enter PIN again. If the correct PIN is not entered, the on-board computer will switch off after 60 seconds.

### 6.14.2 Switching off the on-board computer

If the system is not used for 10 minutes, the on-board computer will switch off automatically.

- ▶ Press and hold the **On-Off button (control panel)** for about 2 seconds to switch the on-board computer off.

### 6.14.3 Using the riding light

- ✓ To switch on the *riding light*, the drive system needs to be switched on first.
- ▶ Press the **up button** for a long time (> 1 second).
  - ⇒ The headlight is now switched on. The backlight switches from daytime to night mode. The riding light symbol is activated.
  - ⇒ The interface daytime and night modes are displayed as follows:
- ▶ Press the **up button** for a long time (> 1 second).
  - ⇒ The headlight is switched off. The backlight switches from night to daytime mode. The riding light symbol is deactivated.

### 6.14.4 Using the push assist system



#### Injury from pedals or wheels

The pedals and the drive wheel turn when the push assist system is used. There is a risk of injury if the pedelec wheels are not in contact with the ground when the push assist system is used (e.g. when carrying the pedelec up stairs or when placing it on a bicycle rack).

- ▶ Only use the push assist mode when pushing the pedelec.
- ▶ You must steer the pedelec securely with both hands when using push assist.
- ▶ Allow for enough freedom of movement for the pedals.

#### Crash caused by strong acceleration

If the pedals are pressed with the push assist activated, the pedelec accelerates rapidly. This may cause a crash with injuries.

- ▶ Never mount the pedelec with the push assist activated.

The pedals turn when using the push assist due to the system design.

- ▶ You must steer the pedelec securely with both hands when using push assist.
- ▶ Allow for enough freedom of movement for the pedals.
- ▶ Never use a push assist for slow riding.

The push assist helps the rider to push the pedelec. The maximum speed can be 6 km/h here.

- 1 Press the **down button** for a long time (> 2 seconds).  
⇒ The push assist is activated. **WALK** is displayed.

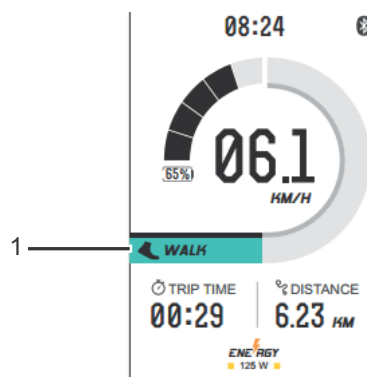

Figure 49: Display screen when push assist activated with WALK displayed

- 2 Release the **push assist button** to shut off the push assist.

### 6.14.5 Selecting the level of assistance

- ▶ Press the **up button**.  
⇒ The level of assistance is increased.
- ▶ Press the **down button**.  
⇒ The level of assistance is reduced.

Symbol	Designation	Area of use
	OFF	Riding without motor assistance
	ECO	Low assistance for maximum battery life. Best assistance when starting up.
	TOUR	Continuous assistance, suitable for long distances with a long battery life.
	SPORT	Sports riding for medium to short trip distances.
	TURBO	High level of assistance on inclines or short distances on urban roads.

Table 32: Overview of levels of assistance

### 6.14.6 Switching the journey information

► Press the **function button** briefly.

The function display shows three different items of journey information one after the other:

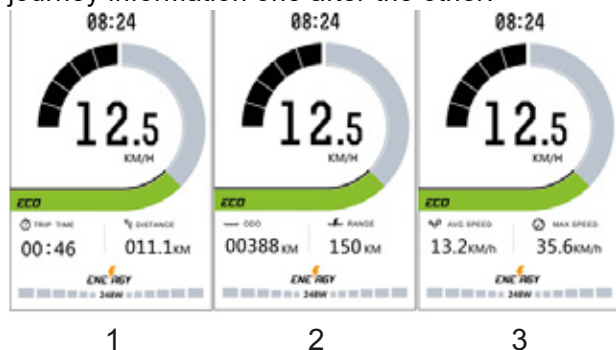

Figure 50: Journey information indicator

Designation	Function
1	Trip time Trip time
2	ODO Total kilometres
3	AVG Speed Average speed

Table 33: Overview of journey information

### 6.14.7 Changing the system information

✓ The drive system must be switched on for at least 10 seconds.

► Press the **function button** for a long time (> 3 seconds).

The <Set screen> will open.

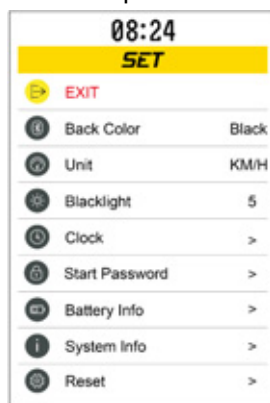

Figure 51: <Set screen>

The rider can change the values of the system settings.

Designation	Function
BACK COLOR	Setting background colour
UNIT	Changing the units
BACKLIGHT	Set the backlight brightness
CLOCK	Setting the clock
SET PASSWORD	Changing the password
BATTERY INFO	Display battery information
SYSTEM INFO	Display system information
RESET	Reset to factory setting

Table 34: List of system settings

The activated menu item is highlighted in yellow.

- The <Set screen> closes if no entry is made for 10 seconds.
- Use the **up button** and **down button** to scroll through the menu.
- Press the **function button** to open a sub-menu option.
- Press the **function button** for a long time (> 3 seconds) to **change the setting or return to the main display screen**.
- To close the <Set screen>, **select the EXIT menu option and press the function button briefly**.

#### 6.14.7.1 Setting background colour

1 Press the BACK COLOR menu sub-item on the <Set screen>.



Figure 52: <BACK COLOR screen>

- 2 Press the **up button** or **down button** briefly to select white or black.
  - 3 Press the **function button** briefly.
- ⇒ The selected background is saved and will be used from now on.

### 6.14.7.2 Setting units

- 1 Press the UNIT menu sub-item on the <Set screen>.

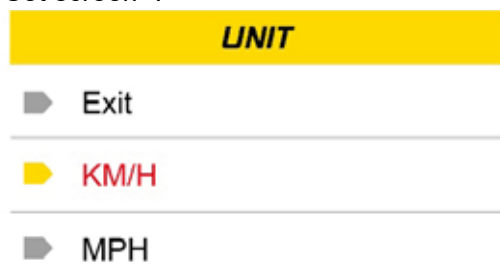

Figure 53: <UNIT indicator>

- 2 Press the **up button** or **down button** briefly to **select km/h (kilometres per hour) or MPH (miles per hour)**.

- 3 **Press the function button** briefly.

⇒ The selected unit is saved and will be used from now on.

### 6.14.7.3 Adjusts the backlight

- 1 Press the BACKLIGHT menu sub-item on the <Set screen>.

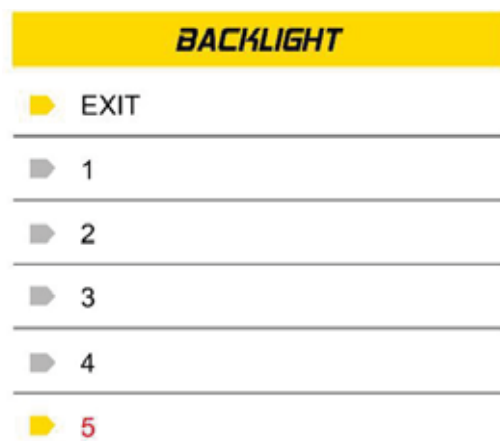

Figure 54: <BACKLIGHT indicator>

⇒ **You can choose a setting from 1 to 5.**

- 2 Press the **up button** or **down button** briefly to **select the brightness level**.

- 3 **Press the function button** briefly.

⇒ The selected unit is saved and will be used from now on.

### 6.14.7.4 Setting the clock

- 1 Press CLOCK menu sub-item on the <Set screen>.

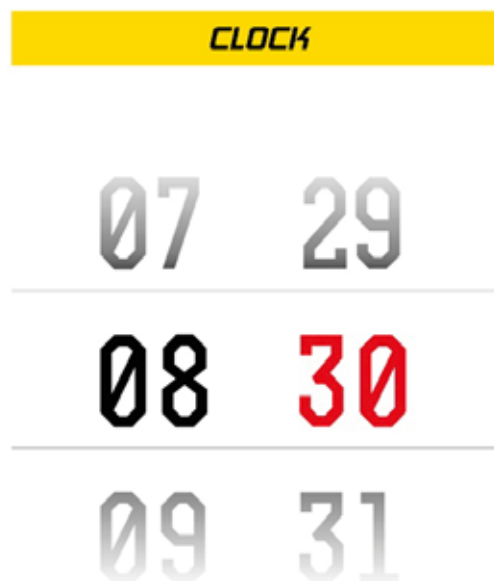

Figure 55: <CLOCK indicator>

- 2 Press the **up button** or **down button** briefly to **set the time**.

- 3 **Press the function button** briefly.

- 4 Press the **up button** or **down button** briefly to **set the minutes**.

- 5 **Press the function button** briefly.

⇒ The set time is saved and will be used from now on.

### 6.14.7.5 Switching the PIN prompt on and off

- 1 Press the SET PASSWORD menu sub-item on the <Set screen>.

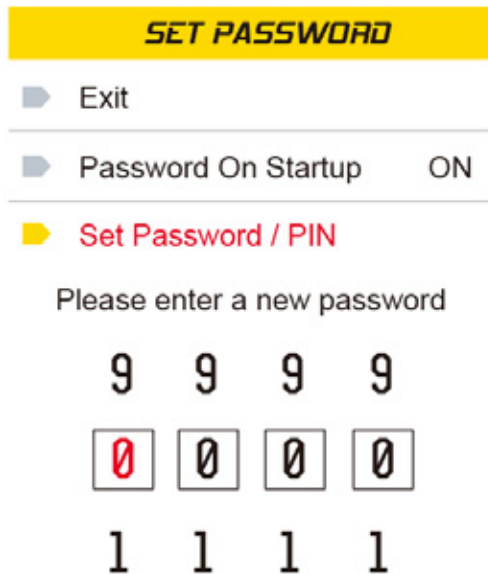

Figure 56: <SET PASSWORD screen>

- 2 Press the <Password On Startup> menu sub-item.
  - 3 Select <ON> or <OFF>.
  - 4 Press the function button briefly.
- ⇒ The PIN prompt will function as selected and is now being used.

### 6.14.7.6 Changing the PIN

- ✓ The PIN prompt is switched on.
- 1 Press the SET PASSWORD menu sub-item on the <Set screen>.
  - 1 <SET PASSWORD screen>
  - ✓ Press the SET PASSWORD menu sub-item on the <Set screen>.

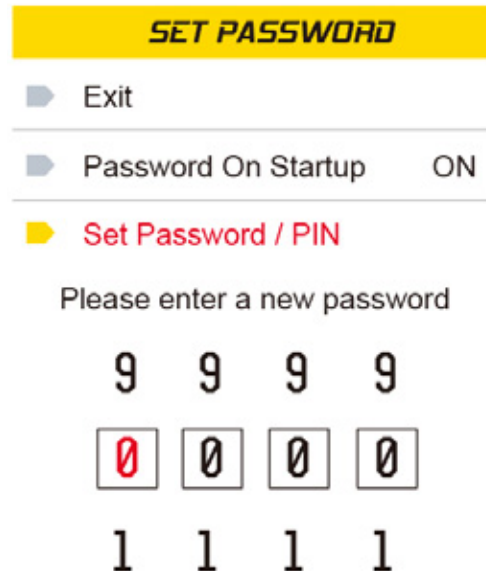

Figure 57: <SET PASSWORD screen>

- 2 Press the <Password On Startup> menu sub-item.
  - 3 Press the **up button** or **down button** briefly to enter the new PIN.
  - 4 Press the **function button** briefly.
  - 5 Press the **up button** or **down button** briefly to enter the new PIN again.
  - 6 Press the **function button** briefly.
- ⇒ The on-board computer will re-start.
- ⇒ The new PIN is saved and will be used from now on.

### 6.14.7.7 Resetting the settings

- ✓ Press RESET menu sub-item on the <Set screen>.

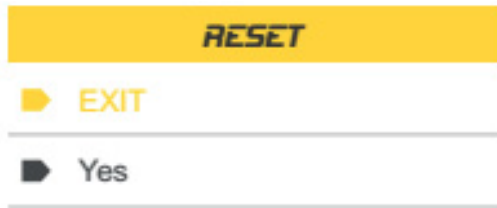

Figure 58: <RESET screen>

- ▶ Press the **up button** or **down button** briefly to select YES.
- ⇒ Press the **function button** briefly.
- ⇒ All settings are re-set to the factory settings.

## 6.15 Brake

### WARNING

#### Crash caused by brake failure

If the brakes are applied continuously for a long time (e.g. while riding downhill for a long time), the fluid in the brake system may heat up. This may create a vapour bubble. Any air bubbles or water contained in the brake system may expand due to heat. This may suddenly make the lever travel wider. This may cause a crash with serious injuries.

- ▶ Release the brake regularly when riding downhill for a longer period of time.
- ▶ Never use the pedelec if the brakes don't work properly or you can feel no resistance when you grip the brake handle. Consult a specialist dealer.

The drive force of the motor is shut off during the ride as soon as the rider no longer pedals. The drive system does not switch off when braking.

Correct handling of the brake helps control the pedelec and prevents crashes.

- ▶ In order to achieve optimum braking results, do not pedal while braking.
- ▶ Shift your body weight backwards and down as far as possible.
- ▶ Practice braking and emergency braking before using the pedelec in public spaces.

### 6.15.1 Using the brake lever

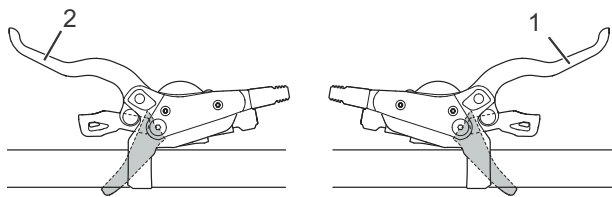

Figure 59: Front (2) and rear (1) brake lever – Shimano brake used as an example

- ▶ Push the left-hand *brake lever* to apply the *front wheel brake*.
- ▶ Push the right-hand *brake lever* to apply the *rear wheel brake*.



## 6.16 Suspension and damping

### 6.16.1 Suspension fork compression adjuster

The compression adjuster makes it possible to make quick adjustments to the fork's suspension behaviour to adapt to changes in terrain. It is intended for adjustments made during the ride. The compression adjuster controls the compression lifting speed or the rate at which the fork deflects slow impacts. The compression adjuster influences the absorption of bumps and its efficiency when the rider's weight shifts or

during transitions, cornering, uniform impacts caused by bumps and when braking.

When optimally adjusted, the fork counteracts deflection, stays higher in its deflection range and helps the rider to maintain speed while riding on hilly parts of terrain. The fork deflects quickly and unhindered when the bike hits a bump and absorbs the bump. Traction is retained (blue line).



Figure 60: Optimum performance on hilly terrain

#### Compression adjuster set to hard

- Causes the suspension fork to move higher within the deflection range. This makes it easier for the rider to improve efficiency and maintain momentum over uniformly hilly terrain and around bends.
- Deflection may feel somewhat harder on more rugged terrain.

#### Compression adjuster set to soft

- Causes the fork to deflect quickly and easily. This may make it easier for the rider to maintain speed and momentum when riding over more rugged terrain.
- Deflection may feel somewhat less hard on more rugged terrain.



Figure 61: Optimum performance over bumps

When optimally adjusted, the fork deflects quickly and unhindered when the bike hits bumps and absorbs a bump. Traction is retained (blue line). The fork responds quickly to the bump. The headset and handlebars rise slightly when absorbing a bump (green line).

#### Threshold

The damping threshold prevents deflection until a medium impact or downward force occurs. Threshold mode increases drive efficiency over level terrain.

The threshold setting can be used to improve pedalling efficiency over flat, hilly, level or slightly rugged terrain. In threshold mode, higher pedelec speeds lead to greater impact force when a pedelec hits a bump, causing the fork to deflect, and the bump is absorbed.

### The fork threshold

- When the compression adjuster is in the open position (against the stop in an anti-clockwise direction), the suspension fork deflects quickly and unhindered through its entire deflection range when an impact or downward force occurs.
- When the compression adjuster is in the threshold position, the suspension fork counteracts deflection until a medium impact or downward force occurs.
- When the compression adjuster is in the blocked position (against the stop in a clockwise direction), the suspension fork counteracts deflection throughout its deflection range until a strong impact or downward force occurs.

#### 6.16.1.1 Adjusting the Suntour compression adjuster

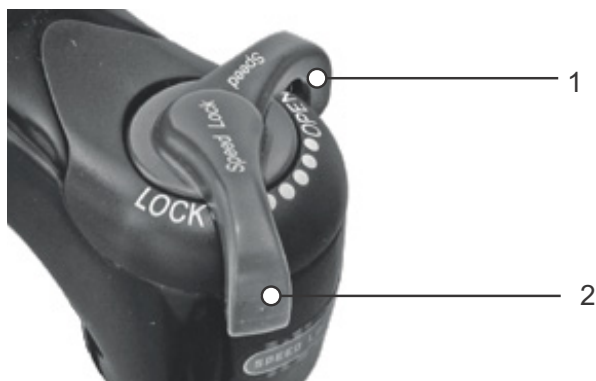

**Figure 62: Suntour compression adjuster in open (1) and closed (2) position**

- ▶ The compression adjuster is open in the OPEN position.
- ▶ The compression adjuster is blocked in the LOCK position.
- ▶ The positions between OPEN and LOCK provide fine adjustment of compression damping. We recommend setting the compression adjuster to the OPEN position first.

## 6.17 Gear shift

The selection of the appropriate gear is a prerequisite for a physically comfortable ride and making sure that the electric drive system functions properly. The ideal pedalling frequency is between 70 and 80 revolutions per minute.

- ▶ Stop pedalling briefly when changing gears. This makes it easier to switch gears and reduces wear on the drivetrain.

### 6.17.1 Using the derailleur gears

Only applies to pedelecs with this equipment

The speed and range can be increased while applying the same force if you select the right gear. Use the derailleur gears.

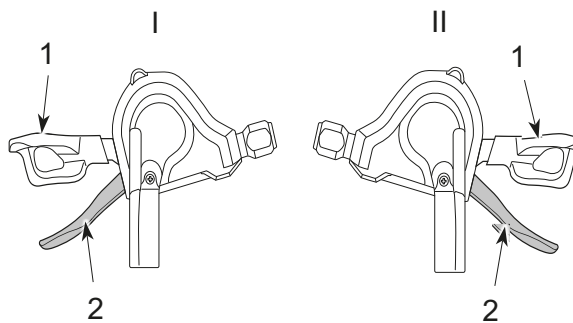

Figure 63: Down shifter (1) and up shifter (2) on the left (I) and right (II) gear shift

- ▶ Select the appropriate gear with the *shifter*.
- ⇒ The gear shift switches the gear.
- ⇒ The shifter returns to its original position.
- ▶ Clean and lubricate the rear derailleur if gear changes block.

## 6.18 Parking the pedelec

### Notice

Heat or direct sunlight can cause the *tyre pressure* to increase above the permitted maximum pressure. This can destroy the *tyres*.

- ▶ Never park the pedelec in the sun.
- ▶ On hot days, regularly check the *tyre pressure* and adjust it as necessary.

---

Moisture penetrating at low temperatures may impair individual functions due to the open structural design.

- ▶ Always keep the pedelec dry and free from frost.
- ▶ If the pedelec is to be used at temperatures below 3 °C, the specialist dealer must carry out an inspection and prepare it for winter use.

---

The pedelec's force of weight may cause the kickstand to sink into soft ground, possibly causing the pedelec to topple over as a result.

- ▶ Park the pedelec on firm, level ground only.

- 
- 1 Switch off the drive system (see Section 6.13.2).
  - 2 After getting off, use your foot to lower the kickstand completely before parking. Ensure that it is stable.
  - 3 Park the pedelec carefully and check that it is stable.
  - 4 Clean the suspension fork and pedals (see Section 7.1.)
  - 5 Protect the saddle with a saddle cover if you park the pedelec outside.
  - 6 Secure the pedelec with a bicycle lock.
  - 7 Remove the battery (see Section 6.12) and, where necessary, your mobile (see Section 6.7.4) to ensure protection against theft.

## 7 Cleaning and servicing

### Cleaning check list

<input type="checkbox"/>	Clean the pedals	after each ride
<input type="checkbox"/>	Clean the suspension fork and, if necessary, rear frame damper	after each ride
<input type="checkbox"/>	Cleaning the battery	once a month
<input type="checkbox"/>	Chain (mainly tarmacked road)	every 250–300 km
<input type="checkbox"/>	Basic cleaning and preservation of all components	at least every six months
<input type="checkbox"/>	Clean the charger	at least every six months
<input type="checkbox"/>	Clean and lubricate the height-adjustable seat post	every six months

### Maintenance check list

<input type="checkbox"/>	Check USB rubber cover position	before each ride
<input type="checkbox"/>	Check for tyre wear	once a week
<input type="checkbox"/>	Check for rim wear	once a week
<input type="checkbox"/>	Check tyre pressure	once a week
<input type="checkbox"/>	Check brakes for wear	once a month
<input type="checkbox"/>	Check electrical cables and Bowden cables for damage and ensure they are fully functional	once a month
<input type="checkbox"/>	Check chain tension	once a month
<input type="checkbox"/>	Check tension of the spokes	every three months
<input type="checkbox"/>	Check the gear shift setting	every three months
<input type="checkbox"/>	Check suspension fork and, if necessary, rear frame damper for wear and ensure fully functional	every three months
<input type="checkbox"/>	Check for wear on brake discs	at least every six months



### Crash and falling caused by unintentional activation

There is a risk of injury if the drive system is activated unintentionally.

- ▶ Remove the battery before cleaning.

Servicing measures must be performed regularly. Contact your specialist dealer if you are unsure.

## 7.1 Cleaning after each ride

### Required tools and cleaning agents:

- Cloth
- Air pump
- Brush
- Water
- Dish-washing liquid
- Bucket

### 7.1.1 Cleaning the suspension fork

- ▶ Remove dirt and deposits from the stanchions and deflector seals with a damp cloth.
- ▶ Check the stanchions for dents, scratches, staining or leaking oil.
- ▶ Check the air pressure.
- ▶ Lubricate the dust seals and stanchions.

### 7.1.2 Cleaning the rear frame damper

- ▶ Remove dirt and deposits from the damper body with a damp cloth.
- ▶ Check rear frame damper for dents, scratches, staining or leaking oil.

### 7.1.3 Cleaning the pedals

- ▶ Clean with a brush and soapy water after riding through dirt or rain.
- ⇒ Service the pedals after cleaning.

## 7.2 Basic cleaning



### CAUTION

#### Crash caused by brake failure

The braking effect may be unusually poor temporarily after cleaning, servicing or repairs. This may cause a crash with injuries.

- ▶ Never apply care products or oil to the brake discs or brake linings, or the braking surfaces on the rims.
- ▶ After cleaning, servicing or repair, carry out a few test brake applications.

### Notice

Water may enter the inside of the bearings if you use a steam jet. This dilutes the lubricant inside, the friction increases and, as a result, the bearings are permanently damaged in the long term.

- ▶ Never clean the pedelec with a pressure washer.

Greased parts, such as the seat post, the handlebars or the stem, may no longer be safely and reliably clamped.

- ▶ Never apply grease or oil to clamping sections.

#### Required tools and cleaning agents:

- Cloths
- Sponge
- Air pump
- Brush
- Toothbrush
- Paintbrush
- Watering can
- Bucket
- Water
- Dish-washing liquid
- Degreaser
- Lubricant
- Brake cleaner or spirit

- ✓ Remove battery before basic cleaning.

### 7.2.1 Cleaning the frame

- 1 Soak the entire frame with dish-washing detergent if the dirt is thick and ingrained.
- 2 After leaving it to soak for a short time, remove the dirt and mud with a sponge, brush and toothbrushes.
- 3 Use a watering can or your hand to rinse the frame.
- 4 Service the frame after cleaning.

### 7.2.2 Cleaning the stem

- 1 Clean stem with a cloth and soapy water.
- 2 Service the stem after cleaning.

### 7.2.3 Cleaning the wheel



### WARNING

#### Crash caused by braking hard on rims

A rim can break and block the wheel if you brake hard. This may cause a crash with serious injuries.

Check rim *wear* on a regular basis.

- 1 Check the tyres, rims, spokes and spoke nipples for any damage while cleaning the wheel.
- 2 Use a sponge and a brush to clean the hub and spokes from the inside to the outside.
- 3 Clean the rim with a sponge.

### 7.2.4 Cleaning the drive elements

- 1 Spray the cassette, the chain wheels and the front derailleur with a degreasing agent.
- 2 Clean coarse dirt with a brush after soaking for a short time.
- 3 Wash down all parts with dish-washing detergent and a toothbrush.
- 4 Service the drive elements after cleaning.

### 7.2.5 Cleaning the rear frame damper

[Only applies to pedelecs with this equipment](#)

- ▶ Clean rear frame damper with a cloth and soapy water.

### 7.2.6 Cleaning the chain

#### Notice

- ▶ Never use aggressive (acid-based) cleaners, rust removers or degreasers when cleaning the chain.
- ▶ Never use chain cleaning devices or chain cleaning baths.

- 1 Slightly dampen a brush with dish-washing liquid. Brush both sides of the chain.
- 2 Dampen a cloth with soapy water. Place the cloth on the chain.
- 3 Hold and apply slight pressure while slowly turning the rear wheel, so the chain passes through the cloth.
- 4 If the chain is still dirty afterwards, clean with lubricant.
- 5 Service the chain after cleaning.

### 7.2.7 Cleaning the battery

#### CAUTION

#### Risk of fire and explosion due to penetration by water

The battery is only protected from simple spray water. Penetration by water can cause a short circuit. The battery may self-ignite and explode.

- ▶ Never clean the battery with a pressure washer, water jet or compressed air.
- ▶ Keep contacts dry and clean.
- ▶ Never immerse the battery in water.
- ▶ Never use cleaning agents.
- ▶ Remove the battery from the pedelec before cleaning.

#### Notice

- ▶ Never clean the battery with cleaning agents or with solvents, such as oil, thinners, alcohol or corrosion protection.
- 
- ▶ Clean the battery electrical connections with a dry cloth or paintbrush only.
  - ▶ Wipe off the decorative sides with a damp cloth.

### 7.2.8 Cleaning the on-board computer

#### Notice

If water enters the on-board computer, it will be permanently damaged.

- ▶ Never immerse the on-board computer in water.
  - ▶ Never clean with a pressure washer, water jet or compressed air.
  - ▶ Never use cleaning agents.
- 
- ▶ Carefully clean the on-board computer with a soft, damp cloth.

### 7.2.9 Cleaning the motor

#### CAUTION

#### Burns from hot motor

The motor cooler can become extremely hot during use. Touching it may cause burns.

- ▶ Leave the motor to cool before cleaning.

#### Notice

If water penetrates the motor, it will be permanently damaged.

- ▶ Never immerse the motor in water.
  - ▶ Never clean with a pressure washer, water jet or compressed air.
  - ▶ Never use cleaning agents.
- 
- ▶ Carefully clean the motor with a soft, damp cloth.

## 7.2.10 Cleaning the brake



### Brake failure due to water penetration

The brake seals are unable to withstand high pressures. Damaged brakes can fail and cause an accident with injury.

- ▶ Never clean the pedelec with a pressure washer or compressed air.
  - ▶ Take great care when using a hosepipe. Never point the water jet directly at the seal section.
- 
- ▶ Clean brake and brake discs with a brush, water and dish-washing detergent.
  - ▶ Clean brake discs thoroughly with brake cleaner or spirit.

## 7.3 Servicing

### Required tools and cleaning agents:

- Cloths
- Toothbrushes
- Dish-washing liquid
- Care oil for frames
- Silicone or Teflon oil
- Acid-free lubricating grease
- Fork oil
- Chain oil
- Degreaser
- Spray oil
- Teflon spray

## 7.3.1 Servicing the frame

- ▶ Dry the frame.
- ▶ Spray with care oil.
- ▶ Clean off the care oil again after a short time.

## 7.3.2 Servicing the stem

- ▶ Apply silicone or Teflon oil to the stem shaft tube and the quick release lever pivot point.
- ▶ If you have speedlifter Twist, also apply oil to the unlocking bolt using the groove in the speedlifter body.
- ▶ Apply a little acid-free lubricant grease between the stem quick release lever and the sliding piece to reduce the quick release lever operating force.

## 7.3.3 Servicing the fork

- ▶ Treat the dust seals with fork oil.

## 7.3.4 Servicing the drive elements

- 1 Spray the cassette, the chain wheels and the front derailleur with a degreasing agent.
- 2 Clean coarse dirt with a brush after soaking for a short time.
- 3 Wash down all parts with dish-washing detergent and a toothbrush.
- 4 Treat front and rear derailleur articulated shafts and jockey wheels with Teflon spray.

## 7.3.5 Servicing the pedals

- ▶ Treat pedals with spray oil.

## 7.3.6 Servicing the chain

- ▶ Lubricate the chain thoroughly with chain oil.



## 7.4 Maintenance



### Crash and falling caused by unintentional activation

There is a risk of injury if the drive system is activated unintentionally.

- ▶ Remove the battery before maintenance.

The following maintenance measures must be performed on a regular basis.

### 7.4.1 Wheel



#### Crash caused by braking hard on rims

A rim can break and block the wheel if you brake hard. This may cause a crash with serious injuries.

- ▶ Check rim *wear* on a regular basis.

#### Notice

If the tyre pressure is too low in the tyre, the tyre does not achieve its load bearing capacity. The tyre is not stable and may come off the rim.

If the tyre pressure is too high, the tyre may burst.

- ▶ Check the tyre pressure as per specifications.
- ▶ *Adjust the tyre pressure* as necessary.

- 1 Check the *tyres* for wear.
- 2 Check the *tyre pressure*.
- 3 Check the *rims* for wear.

- ⇒ The rims of a rim brake with invisible wear indicator are worn as soon as the wear indicator becomes visible in the area of the rim joint.
- ⇒ The rims with visible wear indicator are worn as soon as the black, all-round groove on the pad friction surface is no longer visible. We recommend that you also replace the *rims* with every second brake lining replacement.
- 4 Check the tension of the spokes.

### 7.4.1.1 Checking the tyres

- ▶ Check the tyre wear. The tyre is worn if the anti-puncture protection or the carcass cords are visible.
- ⇒ A specialist dealer will need to change the tyre if it is worn.

### 7.4.1.2 Checking the rims

- ▶ Check the *rims* for wear. The rims are worn as soon as the black, all-round groove on the pad friction surface becomes invisible.
- ⇒ Contact your specialist dealer to have the rims replaced. We recommend that you also replace the *rims* at the same time as every second brake lining replacement.

### 7.4.1.3 Checking and adjusting the tyre pressure – Dunlop valve

Only applies to pedelecs with this equipment



The tyre pressure cannot be measured on the simple Dunlop valve. The tyre pressure is therefore measured in the filling hose when pumping slowly with the bicycle pump.

It is recommendable to use a bicycle pump with a pressure gauge. The operating instructions for the bicycle pump must be adhered to.

- 1 Unscrew and remove the valve cap.
- 2 Connect the bicycle pump.
- 3 Pump up the tyre slowly and pay attention to the tyre pressure in the process.
- 4 Correct the tyre pressure according to specifications in the Pedelec pass.
- 5 If the tyre pressure is too high, unfasten the union nut, let air out and re-tighten the union nut.
- 6 Remove the bicycle pump.
- 7 Screw the valve cap tight.
- 8 Screw the rim nut gently against the rim with the tips of your fingers.

#### 7.4.1.4 Checking and adjusting the tyre pressure – Presta valve

Only applies to pedelecs with this equipment



✓ It is recommendable to use a bicycle pump with a pressure gauge. The operating instructions for the bicycle pump must be adhered to.

- 1 Unscrew and remove the valve cap.
  - 2 Open the knurled nut around four turns.
  - 3 Carefully apply the bicycle pump so that the valve insert is not bent.
- 4 Pump up the tyre slowly and pay attention to the tyre pressure in the process.
  - 5 Correct the tyre pressure as per the specifications on the tyre.
  - 6 Remove the bicycle pump.
  - 7 Tighten the knurled nut with your fingers.
  - 8 Screw the valve cap tight.
  - 9 Screw the rim nut gently against the rim with the tips of your fingers.

#### 7.4.1.5 Checking and adjusting the tyre pressure – Schrader valve

Only applies to pedelecs with this equipment



✓ It is recommendable to use a bicycle pump with a pressure gauge. The operating instructions for the bicycle pump must be adhered to.

- 1 Unscrew and remove the valve cap.
  - 2 Attach the bicycle pump.
  - 3 Pump up the tyre slowly and pay attention to the tyre pressure in the process.
- ⇒ The tyre pressure has been adjusted as per the specifications.
- 4 Remove the bicycle pump.
  - 5 Screw the valve cap tight.
  - 6 Screw the rim nut (1) gently against the rim with the tips of your fingers.

#### 7.4.2 Brake system



##### Crash caused by brake failure

Worn brake discs and brake linings, as well as a lack of hydraulic fluid in the brake cable, reduce the braking power. This may cause a crash with injuries.

- ▶ Check the brake disc, brake linings and hydraulic brake system on a regular basis. Contact your specialist dealer if any of these components have become worn.

The maintenance interval for the brake depends on the weather conditions and how frequent the bicycle is used. If the pedelec is used under extreme conditions such as rain, dirt or high mileage, maintenance must be performed more frequently.

#### 7.4.3 Checking the brake linings for wear

Check brake linings after brake has been fully applied 1,000 times.

- 1 Check that the brake linings are no less than 1.8 mm wide at any point and no less than 2.5 mm between the brake lining and supporting plate.
  - 2 Push brake lever and hold. In doing so, check the transport safety wear gauge can fit between the brake lining supporting plates.
- ⇒ The brake linings have not reached their wear limit. Contact your specialist dealer if any of these components have become worn.

#### 7.4.4 Checking the pressure point

- ▶ Pull brake lever and hold repeatedly several times.
- ⇒ If you are unable to clearly detect the pressure point and it changes, the brake needs to be vented. Contact your specialist dealer.

#### 7.4.5 Checking the brake discs for wear

- ▶ Check that the brake disc measures no less than 1.8 mm in depth at any point.
- ⇒ The brake discs have not reached their wear limit yet; brake discs need to be replaced if they have. Contact your specialist dealer.

#### 7.4.6 Checking the electrical cables and brake cables

- ▶ Check all visible electrical cables and Bowden cables for damage. If the sheathing is compressed, a brake is defective or a light does not work, the pedelec must be removed from service until the lines or cables have been repaired. Contact your specialist dealer.

#### 7.4.7 Checking the gear shift

- ▶ Check the gear shift and the *shifter* or the *gear twist grip* setting and adjust as necessary.

#### 7.4.8 Checking the stem

- ▶ The stem and quick release system must be inspected at regular intervals. The specialist dealer should adjust them if necessary.
- ▶ If the hexagon socket head screw is also loosened, the headset backlash also needs to be adjusted. Medium-strength thread locker, such as Loctite blue, then needs to be applied to the loosened screws and the screws tightened as per specifications.
- ▶ Contact your specialist dealer if there is any wear or signs of corrosion.

#### 7.4.9 Checking the belt and chain tension

##### Notice

Excessive chain tension increases wear.

If the chain tension is too low, there is a risk that the *chain* or the *drive belt* will slip off the *chain wheels*.

- ▶ Check the chain tension once a month.

- 1 Check the chain tension in three or four positions, turning the crank a full revolution.

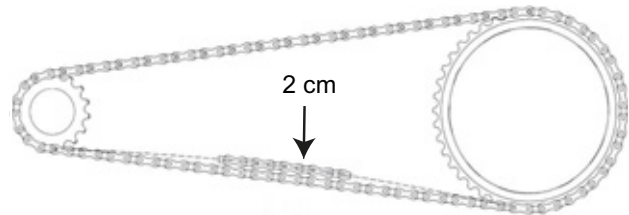

Figure 64: Checking the chain tension

- 2 If the *chain* can be pushed more than 2 cm, the *chain* or *drive belt* will need to be tensioned again by the specialist dealer.
  - 3 If the *chain* or the *drive belt* can only be pushed up and down less than 1 cm, you will need to slacken the *chain* or the *drive belt*.
- ⇒ The optimum chain tension is achieved if the *chain* or the *drive belt* can be pushed a maximum of 2 cm in the middle between the pinion and the toothed wheel. The crank must also turn without resistance.
- 4 If a hub gear is fitted, the rear wheel must be pushed backwards or forwards to tighten the chain. Contact your specialist dealer.
  - 5 Check the handlebar grip is firmly in position.



## 8 Maintenance

### WARNING

#### Injury due to damaged brakes

Special tools and specialist knowledge are required to repair the brakes. Incorrect or unauthorised assembly can damage the brakes. This may lead to an accident with injuries.

- ▶ Only specialist dealers may carry out repairs on brakes.
- ▶ Only carry out work or changes, such as dismantling, sanding or painting, which are permitted and described in the brake operating instructions.

#### Injury to the eyes

Problems may arise if the settings are not made properly and you may sustain serious injuries as a result.

- ▶ Always wear safety glasses during maintenance work.

### CAUTION

#### Crash and falling caused by unintentional activation

There is a risk of injury if the drive system is activated unintentionally.

- ▶ Remove the battery before inspection.

#### Crash caused by material fatigue

If the service life of a component has expired, the component may suddenly fail. This may cause a crash with injuries.

- ▶ Have the specialist dealer carry out basic cleaning of the pedelec every six months, preferably at the same time as the required servicing work.

### CAUTION

#### Hazard for the environment due to toxic substances

The brake system contains toxic and environmentally harmful oils and lubricants. Such fluids will contaminate if they enter the sewers or groundwater.

- ▶ Dispose of lubricants and oils left over after repairs in an environmentally responsible way in accordance with statutory regulations.

### Notice

The motor is maintenance-free and may only be opened by qualified specialist personnel.

- ▶ Never open the motor.

You must have the specialist dealer perform maintenance every six months as a minimum. This is the only way to ensure that the pedelec remains safe and fully functional. No matter whether disc brakes need replacing, brakes venting or wheels changing, many maintenance tasks require technical expertise, special tools and special lubricants. The pedelec may become damaged if the stipulated maintenance intervals and procedures are not carried out. That is why only specialist dealers may carry out maintenance.

- ▶ The retailer will check the pedelec based on the maintenance instructions in Section 11.3.
- ▶ The specialist dealer will inspect the pedelec for any signs of material fatigue during basic cleaning.
- ▶ The specialist dealer will check the software version of the drive system and update it. The electrical connections are checked, cleaned and preservative agent is applied. The electrical cables are inspected for damage.

- ▶ The specialist dealer will dismantle and clean the entire suspension fork interior and exterior. They will clean and lubricate the dust seals and slide bushings, check the torques and adjust the fork to the rider's preferred position. They will also replace the sliding collar if the clearance is too great (more than 1mm on the fork bridge).
- ▶ The specialist dealer will fully inspect the interior and exterior of the rear frame damper, overhaul the rear frame damper, replace all air seals on air forks, overhaul the air suspension, change the oil and replace the dust wipers.
- ▶ They will pay particular attention to rim and brake wear. The spokes are re-tightened in accordance with the findings.

## 8.1 Suspension system

The correct execution of maintenance on the suspension system not only guarantees a long service life, but also ensures optimal performance. Each maintenance interval shows the maximum cycling hours for the corresponding type of recommended maintenance. Depending on terrain and environmental conditions, the performance can be optimised through shorter maintenance intervals.

### 8.1.1 Rear frame damper

Only applies to pedelecs with this equipment

#### Maintenance intervals

RockShox rear frame damper		
<input type="checkbox"/>	Service air chamber assembly	Every 50 hours
<input type="checkbox"/>	Service damper and spring	Every 200 hours
FOX rear frame damper		
<input type="checkbox"/>	Complete maintenance (full interior and exterior inspection, damper overhaul, air spring overhaul, oil change and dust wiper replacement)	Every 125 hours or once a year
Suntour rear frame damper		
<input type="checkbox"/>	Complete shock absorber service including damper reassembly and air seal replacement	Every 100 hours

### WARNING

#### Injury due to explosion

The air chamber is pressurised. If the air system is serviced in a rear frame damper, it can explode and cause serious injury.

- ▶ Wear safety goggles, protective gloves and safety clothing when assembling or servicing the vehicle.
- ▶ Release the air for the air chambers. Detach all air insert fitments.
- ▶ Never service or dismantle a rear frame damper if it has not completely rebounded.

### WARNING

#### Intoxication from suspension oil

Suspension oil irritates the respiratory tract, leads to germ cell mutations and sterility, causes cancer and is toxic to touch.

- ▶ Always wear safety goggles and nitrile gloves when working with suspension oil.
- ▶ Never perform maintenance when you are pregnant.
- ▶ Use an oil catchment tray under the section where the rear frame damper is serviced.

### CAUTION

#### Hazard for the environment due to toxic substances

The rear frame damper contains toxic and environmentally harmful oils and lubricants. Such fluids will contaminate if they enter the sewers or groundwater.

- ▶ Dispose of lubricants and oils left over after repairs in an environmentally responsible way in accordance with statutory regulations.

Special tools, special lubricants and knowledge of suspension components are required to maintain and repair the rear frame damper.

The rear frame damper may become damaged if the procedure is not followed as described. Only specialist dealers may carry out maintenance on rear frame damper.

### 8.1.2 Suspension fork

Only applies to pedelecs with this equipment

#### Maintenance intervals

Suntour suspension fork		
<input type="checkbox"/>	<b>Maintenance 1</b> Functional check, fastening and wear test	Every 50 hours
<input type="checkbox"/>	<b>Maintenance 2</b> Maintenance 1 + cleaning entire fork interior and exterior / cleaning and lubrication of dust seals and guides/ plastic bushings / check torques	Every 100 hours
FOX suspension fork		
<input type="checkbox"/>	Full maintenance (complete interior/ exterior inspection, damper overhaul, replacement of air seals on air forks, air suspension overhaul, oil change and dust wiper replacement).	Every 125 hours or once a year
RockShox suspension fork		
<input type="checkbox"/>	Stanchions for: Paragon™, XC™ 28, XC 30, 30™, Judy®, Recon™, Sektor™, 35™*, Bluto™, REBA®, SID®, RS-1™, Revelation™, PIKE®, Lyrik™, Yari™, BoXXer	Every 50 hours
<input type="checkbox"/>	Maintenance of spring and damper unit for: Paragon, XC 28, XC 30,30 (2015 and earlier), Recon (2015 and earlier), Sektor (2015 and earlier), Bluto (2016 and earlier), Revelation (2017 and earlier), REBA (2016 and earlier), SID (2016 and earlier), RS-1 (2017 and earlier), BoXXer (2018 and earlier)	Every 100 hours
<input type="checkbox"/>	Maintenance of spring and damper unit for: 30 (2016+), Judy (2018+), Recon (2016+), Sektor (2016+), 35 (2020+)*, Revelation (2018+), Bluto (2017+), REBA (2017+), SID (2017+), RS-1 (2018+), PIKE (2014+), Lyrik (2016+), Yari (2016+), BoXXer (2019+)	Every 200 hours

## WARNING

### Injury due to explosion

The air chamber is pressurised. If the air system is serviced in a faulty suspension fork, it can explode and cause serious injury.

- ▶ Wear safety goggles, protective gloves and safety clothing when assembling or servicing the vehicle.
- ▶ Release the air for the air chambers. Detach all air insert fitments.
- ▶ Never service or dismantle a suspension fork if it has not completely rebounded.

## CAUTION

### Hazard for the environment due to toxic substances

The suspension fork contains toxic and environmentally harmful oils and lubricants. Such fluids will contaminate if they enter the sewers or groundwater.

- ▶ Dispose of lubricants and oils left over after repairs in an environmentally responsible way in accordance with statutory regulations.

Special tools, special lubricants and knowledge of suspension components are required to service and repair suspension forks.

The suspension fork may be damaged if procedures are not followed as described. Only specialist dealers may carry out maintenance on the suspension fork.

### 8.1.3 Suspension seat post

Only applies to pedelecs with this equipment

#### Maintenance intervals

by.schulz seat post		
<input type="checkbox"/>	Check all screws for correct tightening torques for: G1 and G2	After 250 km and every 1,500 km
Suntour suspension seat post		
<input type="checkbox"/>	<b>Maintenance 1</b>	Every 100 hours
RockShox suspension seat post		
<input type="checkbox"/>	Venting of remote control lever and/or maintenance of lower seat post unit for: Reverb™ A1/A2/B1, Reverb Stealth A1/A2/B1/C1*, Reverb AXS™ A1*	Every 50 hours
<input type="checkbox"/>	Venting of remote control lever and/or maintenance of lower seat post unit for: Reverb B1, Reverb Stealth B1/C1*, Reverb AXS A1*	Every 200 hours
<input type="checkbox"/>	Complete maintenance of seat post for: Reverb A1/A2, Reverb Stealth A1/A2	Every 200 hours
<input type="checkbox"/>	Complete maintenance of seat post for: Reverb B1, Reverb Stealth B1	Every 400 hours
<input type="checkbox"/>	Complete maintenance of seat post for: Reverb AXS A1*, Reverb Stealth C1*	Every 600 hours
All other suspension seat posts		
<input type="checkbox"/>	Maintenance	Every 100 hours

Special tools, special lubricants and knowledge of suspension components are required to service and repair suspension seat posts.

The suspension seat post may be damaged if procedures are not followed as described. Only specialist dealers may carry out maintenance on the suspension seat post.

### 8.2 Axle with quick release



#### Crash caused by unfastened quick release

A faulty or incorrectly installed quick release may become caught in the brake disc and block the wheel. This will cause a crash.

- ▶ Install the front wheel quick release lever on the opposite side to the brake disc.

#### Crash caused by faulty or incorrectly installed quick release

The brake disc becomes very hot during operation. Parts of the quick release may become damaged as a result. The quick release comes loose. This will cause a crash with injuries.

- ▶ The front wheel quick release lever and the brake disc must be situated on opposite sides.

#### Crash caused by incorrectly set clamping force

Excessively high clamping force will damage the quick release and cause it to lose its function.

Insufficient clamping force will cause a detrimental transmission of force. The suspension fork or the frame may break. This will cause a crash with injuries.

- ▶ Never fasten a quick release using a tool (e.g. hammer or pliers).
- ▶ Only use the clamping lever with the specified set clamping force.

### 8.2.1 Checking the quick release

- ▶ Check the position and clamping force of the quick release lever. The quick release lever must be flush with the lower housing. You must be able to see a slight impression on the palm of your hand when you close the quick release lever.



Figure 65: Adjusting the quick release clamping force

- ▶ Use a 4 mm hexagon socket spanner to tighten the clamping lever clamping force if required. Check the quick release lever position and clamping force.

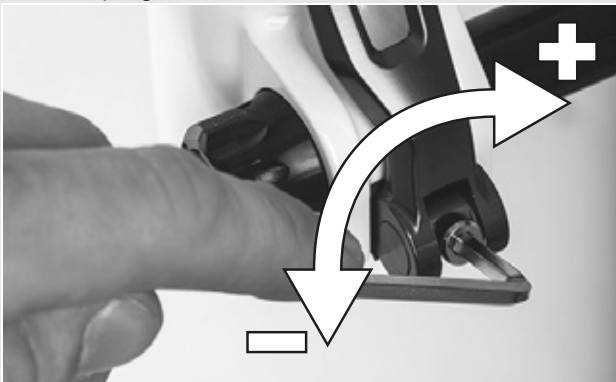

Figure 66: Adjusting the quick release clamping force

### 8.3 Maintaining the stem

Incorrectly fastened screws may come loose due to impact. The stem may no longer be firmly fixed in its position as a result. This will cause a crash with injuries.

- ▶ Check the handlebars and the stem's quick release system are firmly in position after the first two hours of riding.

### 8.4 Adjusting the gear shift

If you cannot select the gears effortlessly, you will need to adjust the setting for the shift cable tension.

- ▶ Carefully pull the *adjusting sleeve* away from the shifter housing, turning it as you do so.
- ▶ Check the gear shift function after each adjustment.

#### 8.4.1 Cable-operated gear shift, single-cable

**Only applies to pedelecs with this equipment**

- ▶ For a smooth gear shift, adjust the adjusting sleeves on the shifter housing.



Figure 67: Adjusting sleeve (1) for the single-cable, cable-operated gear shift with shifter housing (2), example



### 8.4.2 Cable-operated gear shift, dual-cable

#### Only applies to pedelecs with this equipment

- ▶ For a smooth gear shift, set the adjusting sleeves underneath the chain stay on the frame.
- ▶ The shift cable has around 1 mm play when it is pulled out gently.

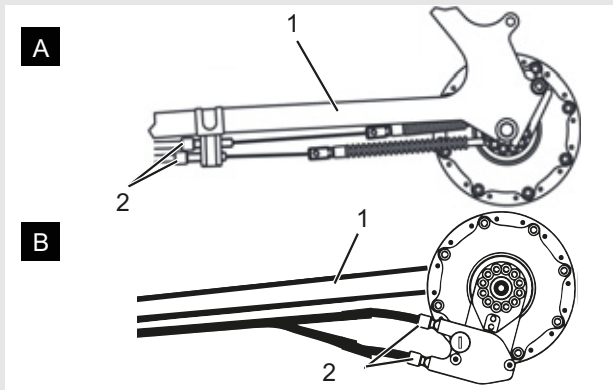

Figure 68: Adjusting sleeves (2) on two alternative versions (A and B) of a dual-cable, cable-operated gear shift on the chain stay (1)

### 8.4.3 Cable-operated twist grip, dual-cable

#### Only applies to pedelecs with this equipment

- ▶ For a smooth gear shift, set the adjusting sleeves on the shifter housing.
- ⇒ There is noticeable play of around 2–5 mm (1/2 gear) when twisting the twist grip.

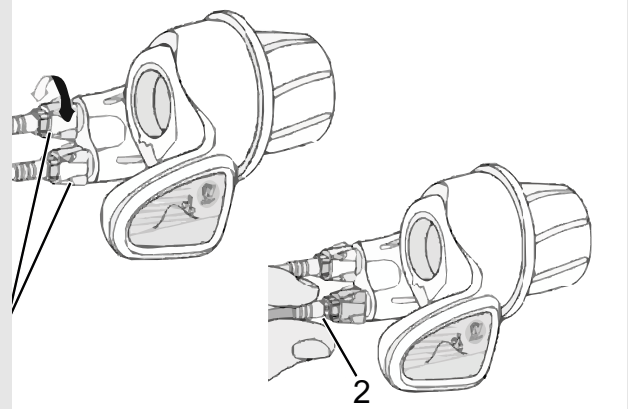

Figure 69: Twist grip with adjusting sleeves (1) and play of the gear shift (2)

## 9 Troubleshooting, fault clearance and repair

### 9.1 Troubleshooting and fault clearance

The components of the drive system are checked constantly and automatically. If an error is detected, an error message appears on the *display*. The drive may be shut off automatically, depending on the type of error.

#### 9.1.1 The drive system or display do not start up

If the display and/or the drive system do not start up, proceed as follows:

- 1 Check whether the battery is switched on. If not, start the battery.
- ⇒ Contact specialist dealer if the battery level indicator LEDs do not light up.
- 2 If the LEDs on the battery level indicator light up, but the drive system does not start up, remove the battery.
- 3 Insert the battery.
- 4 Start the drive system.
- 5 If the drive system does not start up, remove the battery.
- 6 Clean all the contacts with a soft cloth.
- 7 Insert the battery.
- 8 Start the drive system.
- 9 If the drive system does not start up, remove the battery.
- 10 Fully charge the battery.
- 11 Insert the battery.
- 12 Start the drive system.
- 13 If the drive system does not start up, remove the display.
- 14 Fasten the display.
- 15 Start the drive system.
- 16 Contact your specialist dealer if the drive system does not start up.

#### 9.1.2 Error message

If an error message is displayed, run through the following actions:

- 1 Make a note of the system message. There is a table of all error messages in Section 6.2.
- 2 Shut off and re-start the drive system.
- 3 If the system message is still displayed, remove the battery and then re-insert.
- 4 Re-start the drive system.
- 5 If the system message is still displayed, contact your specialist dealer.

### 9.1.3 Assistance function errors

Symptom	Cause	Remedy
Assistance is not available.	Is the battery charged sufficiently?	<ol style="list-style-type: none"> <li>1 Check battery is charged.</li> <li>2 Recharge the battery if it is almost flat.</li> </ol>
	Are you riding up long inclines in summer weather or have you been carrying a heavy load for a long time? The battery may be too hot.	<ol style="list-style-type: none"> <li>1 Switch off the drive system.</li> <li>2 Wait a moment and then check again.</li> </ol>
	The rechargeable battery, the display or the assistance switch may be connected incorrectly or one or more of them may have a problem.	▶ Contact your specialist dealer.
	Is the speed too high?	▶ Check on-screen indicators. The electronic gear assistance only works up to a maximum speed of 25 km/h.
Assistance is not available.	Are the pedals being pushed?	▶ The pedelec is not a motorbike. Push the pedals.
	Is the assistance mode set to [OFF]?	<ol style="list-style-type: none"> <li>1 Set the assistance mode to a different level of assistance than [OFF].</li> <li>2 Contact your specialist dealer if you still feel that the no assistance is being supplied.</li> </ol>
	Is the system switched on?	▶ Press the battery on-off button to switch it on again.
The assisted journey distance is too short.	The journey distance can be shorter depending on the road conditions, the gear level and the entire light usage time.	<ol style="list-style-type: none"> <li>1 Check battery is charged.</li> <li>2 Recharge the battery if it is almost flat.</li> </ol>
	The battery does not perform as well in winter weather.	This does not indicate a problem.
	The battery is a consumable. Repeated charging and long periods of use cause the battery to degrade (loss of power).	▶ If the distance you can cover with one single charge is very short, replace the battery with a new one.
	Is the battery fully charged?	▶ If the distance covered with a fully charged battery has become shorter, the battery may be affected. Replace the battery with a new one.
It is difficult to pedal.	Are the tyres pumped to an adequate pressure?	▶ Pump up tyres.
	Is the assistance mode set to OFF?	<ol style="list-style-type: none"> <li>1 Set level of assistance to [BOOST].</li> <li>2 Contact your specialist dealer if you still feel that the no assistance is being supplied.</li> </ol>
	The battery charge might be low.	▶ Check how powerful assistance is again after charging the battery. Contact your specialist dealer if you still feel that the pedelec does not provide assistance.
	Have you switched on the system with your foot on the pedal?	<ol style="list-style-type: none"> <li>1 Switch the system on again without applying pressure to the pedal. Contact your specialist dealer if you still feel that the pedelec does not supply assistance.</li> </ol>

Table 35: Level of assistance error solution

### 9.1.4 Battery error

Symptom	Cause	Remedy
The battery discharges quickly.	The battery may be at the end of its useful life.	▶ Replace the battery with a new one.
The battery cannot be recharged.	Is the charger mains plug firmly connected to the socket?	<ol style="list-style-type: none"> <li>1 Pull out the charger mains plug and reconnect it again.</li> <li>2 Try charging again.</li> <li>3 If the battery still won't recharge, contact your specialist dealer.</li> </ol>
	Is the charger plug firmly connected to battery?	<ol style="list-style-type: none"> <li>1 Pull out the charger mains plug and reconnect it again.</li> <li>2 Try charging again.</li> <li>3 If the battery still won't recharge, contact your specialist dealer.</li> </ol>
	Is the adapter firmly connected to the charger plug or the battery's charging port?	<ol style="list-style-type: none"> <li>1 Connect the adapter firmly to the charger plug or the battery's charging port.</li> <li>2 Re-start the charging process.</li> <li>3 Contact your specialist dealer if the battery still does not charge.</li> </ol>
	Is the connection terminal for the battery charger, charger adapter or battery dirty?	<ol style="list-style-type: none"> <li>1 Wipe the connection terminal with a dry cloth to clean it.</li> <li>2 Try charging again.</li> <li>3 If the battery still won't recharge, contact your specialist dealer.</li> </ol>
The battery does not start charging when the charger is connected.	The battery may be at the end of its useful life.	▶ Replace the battery with a new one.
The battery and charger become hot.	The temperature of the battery or the charger may have exceeded the operating temperature range.	<ol style="list-style-type: none"> <li>1 Stop the charging process.</li> <li>2 Wait a while and then start charging again.</li> <li>3 If the battery is too hot to touch, there might be a problem with the battery. Contact your specialist dealer.</li> </ol>
The charger is hot.	If the charger is used continuously to charge batteries, it may become hot.	▶ Wait a while before using the charger again.
The LED on the charger does not light up.	Is the charger plug firmly connected to battery?	<ol style="list-style-type: none"> <li>1 Check the connection to the external body before inserting the charger plug again.</li> <li>2 If nothing changes, contact your specialist dealer.</li> </ol>
	Is the battery fully charged?	<p>The LED on the battery charger will go out when the battery is fully charged. This is not a malfunction.</p> <ol style="list-style-type: none"> <li>1 Pull out the charger mains plug and reconnect it again.</li> <li>2 Then try charging again.</li> <li>3 If the LED on the charger still does not light up, contact your specialist dealer.</li> </ol>
The battery cannot be removed.		▶ Contact your specialist dealer.
The battery cannot be inserted.		▶ Contact your specialist dealer.
Fluid is leaking from the battery.		▶ Observe all warnings in Section 2 Safety.

**Table 36: Error solution for battery**

Symptom	Cause	Remedy
There is an unusual smell.		<ol style="list-style-type: none"> <li>1 Move away from the battery immediately.</li> <li>2 Contact the fire service immediately.</li> <li>3 Observe all warnings in Section 2 Safety.</li> </ol>
Fumes are emitted from the battery.		<ol style="list-style-type: none"> <li>1 Move away from the battery immediately.</li> <li>2 Contact the fire service immediately.</li> <li>3 Observe all warnings in Section 2 Safety.</li> </ol>

Table 36: Error solution for battery

### 9.1.5 Display errors

Symptom	Cause	Remedy
No data are shown on the monitor if you press the on-off button on the battery.	The battery charge level may be insufficient.	<ol style="list-style-type: none"> <li>1 Charge the battery.</li> <li>2 Switch the power on.</li> </ol>
	Is the power switched on?	▶ Keep the battery on-off button pressed down to switch on the power again.
	Is the battery charged?	▶ If the battery is fitted to the pedelec and is being charged, it cannot be switched on. Stop the charging process.
	Is the connector fitted to the power cable correctly?	▶ Check that the power cable connector has not been disconnected. If you are not sure, contact your specialist dealer.
	A component may be connected which the system is unable to recognise.	▶ Contact your specialist dealer.
The gear level is not shown on the display screen.	The gear level is only shown if the electronic gear shift is used.	▶ Check whether the power cable pug has been disconnected. If you are not sure, contact your specialist dealer.
The settings menu cannot be opened while you are riding.	The product is designed in such a way that the settings menu cannot be opened if the system detects that someone is riding the pedelec. This is not a malfunction.	▶ Stop the pedelec and then adjust the settings.
The time display is flashing "0:00".	The coin cell in the display has come to the end of its service life.	▶ Replace the coin cell in the display.

Table 37: Display error solution

### 9.1.6 Lighting does not work

Symptom	Cause	Remedy
The front light or rear light does not go on, even when the switch is pressed.	The basic settings in the electric drive system have probably been configured incorrectly. The light is defective.	<ol style="list-style-type: none"> <li>1 Take the pedelec out of service immediately.</li> <li>2 Contact your specialist dealer.</li> </ol>

Table 38: Error solution for battery

### 9.1.7 Other errors

Symptom	Cause	Remedy
Two beeps will sound if a switch is pressed but the switch cannot be operated.	Pressed switch mode has been deactivated.	▶ This is not a malfunction.
Three beeps are sounded.	A fault or warning has occurred.	▶ This occurs when a warning or an error is shown on the display screen. Follow the instructions for the code indicated on screen in Section 6.2 System Messages.
When you use an electronic gear shift, you can feel that pedal assistance becomes weaker when the gear is changed.	This is because the computer sets the pedal assistance to the optimum level.	▶ This is not a malfunction.
A noise can be heard after switching.		▶ Contact your specialist dealer.
It is normal to hear a noise coming from the rear wheel when cycling as normal.	The gear shift setting may not have been made properly.	▶ Contact your specialist dealer.
If you stop the pedelec, gear transmission does not switch to the position pre-configured in the functional feature.	You may have applied too much pressure onto the pedals.	▶ It is easier to change gears if you press onto the pedals gently.

**Table 39: Error solution for battery**

## 9.1.8 Suspension fork

### 9.1.8.1 Rebound too fast

The suspension fork rebounds too quickly, producing a “pogo stick” effect, where the wheel lifts from the ground in an uncontrolled way. This impairs traction and control (blue line).

Fork head and handlebars are deflected upwards if the wheel bounces back from the ground. The rider's weight may be shifted up and back in an uncontrolled way (green line).

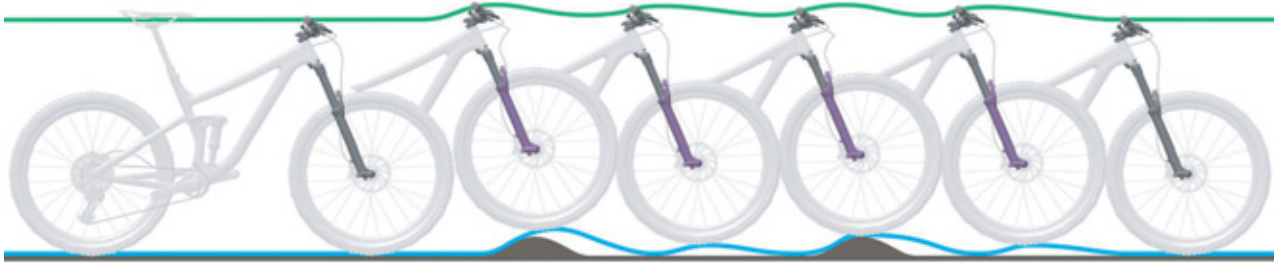

Figure 70: Suspension fork rebounding too quickly

### Solution

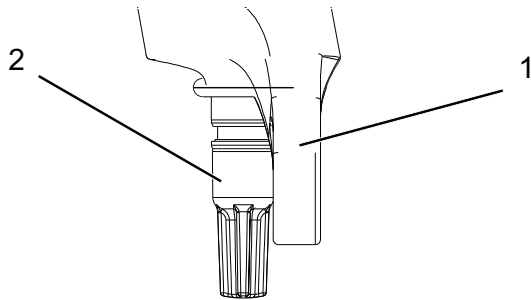

Figure 71: Suntour rebound screw (2), fork (1)

- Turn the rebound adjuster clockwise to reduce the rebound speed and increase traction and control.

### 9.1.8.2 Rebounding too slowly

The fork does not rebound quickly enough after absorbing a bump. The fork also remains deflected over subsequent bumps, which reduces deflection and increases the hardness of impacts. Available deflection, traction and control decrease (blue line).

The fork remains in a deflected state, causing the headset and handlebars to move to a lower position. The rider's weight is shifted forward after the impact (green line).

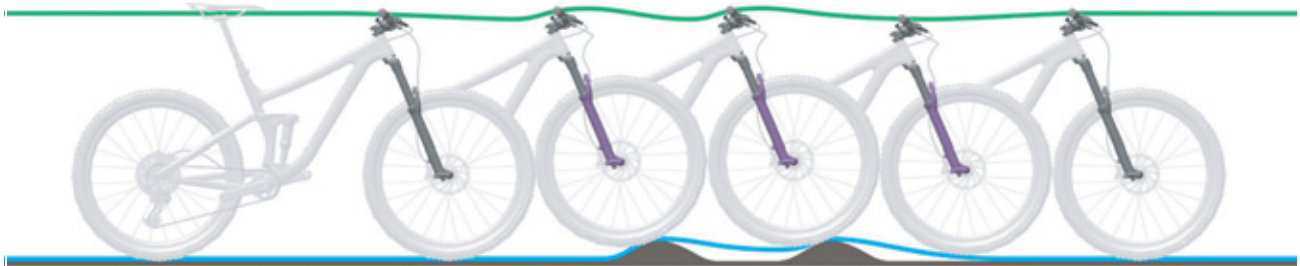
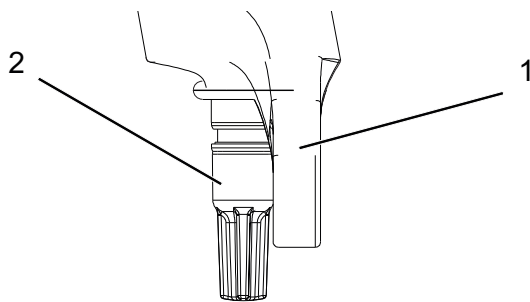

Figure 72: Suspension fork rebounding too slowly

#### Solution



- ▶ Turn the rebound adjuster anti-clockwise to increase the rebound speed and improve performance when riding over bumps.

Figure 73: Suntour rebound screw (2), fork (1)



### 9.1.8.3 Suspension too soft on inclines

The fork deflects at a low point in the terrain. The deflection is quickly used up, the rider's weight

may shift forward and the pedelec will possibly lose some momentum.

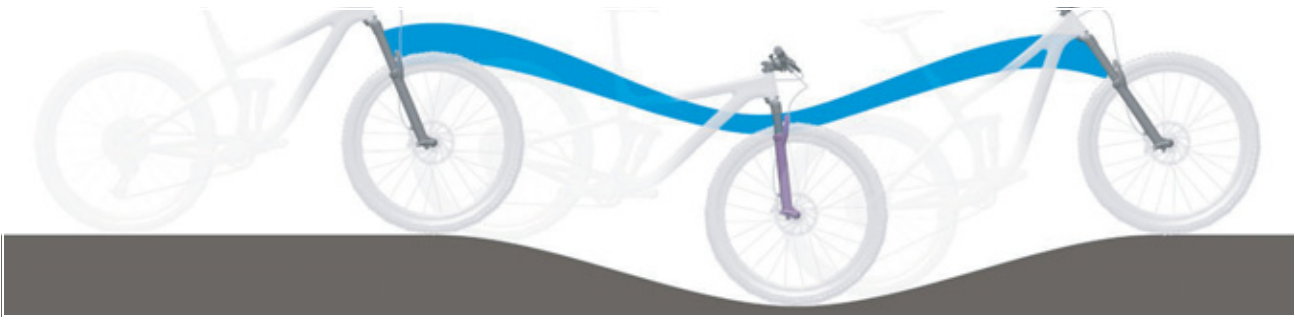

Figure 74: Excessively soft suspension in the suspension fork on hilly terrain

#### Solution



- ▶ To improve efficiency on hilly and flat terrain, turn the compression adjuster clockwise to increase compression damping and hardness and reduce the deflection speed.

Figure 75: Suntour compression adjuster in open (1) and closed (2) position

#### 9.1.8.4 Excessively hard damping on bumps

When the bike hits a bump, the fork deflects too slowly and the wheel lifts up from the bump. Traction decreases when the wheel no longer touches the ground.

The headset and handlebars are deflected upwards significantly, which can impair control.



Figure 76: Excessively hard damping in the suspension fork on bumps

#### Solution



Figure 77: Suntour compression adjuster in open (1) and closed (2) position

- ▶ To increase sensitivity to small bumps, turn the compression adjuster anti-clockwise to decrease damping and hardness and increase the deflection speed.

## 9.2 Repair

Special knowledge and tools are required for many repairs. That is why only a specialist dealer may perform repairs such as:

- Replacing tyres and rims
- Replacing rims and brake linings or brake discs
- Replacing and tensioning the chain.

### 9.2.1 Original parts and lubricants

The individual pedelec parts have been carefully selected and matched to one other.

Only original parts and lubricants must be used for maintenance and repair.

The constantly updated accessory approval and parts lists are in Section 11, Documents and Drawings.

Observe the operating instructions for the new components.

### 9.2.2 Replacing the lighting

- ▶ Only use components of the respective power class for replacement.

### 9.2.3 Adjusting the headlight

- ▶ The *headlight* must be set, so that its light beam shines on the road 10 m in front of the pedelec.

### 9.2.4 Tyre clearance check

The tyre needs to be checked each time a suspension fork tyre is changed to another size.

- 1 Release pressure from the fork.
- 2 Press fork together fully.
- 3 Measure the gap between the top of the tyre and the crown's lower surface. The gap must not be less than 10 mm. If the tyre is too large, the tyre will touch the crown's lower surface if the fork is fully pressed together.
- 4 Release pressure on fork and pump it up again if it is an air suspension fork.
- 5 Take into account the fact that the gap will be smaller if there is a guard. Check again to ensure that there is sufficient clearance for the tyre.

## 10 Recycling and disposal



This device is marked according to the European Directive 2012/19/EU on waste electrical and electronic



equipment – WEEE and the European Directive 2006/66/EC on accumulators.

The directive provides the framework for the return and recycling of used devices across the EU. As a consumer, you are legally required to return all used batteries of any type. It is forbidden to dispose of batteries in domestic waste. The manufacturer is obliged to take back used and old batteries free of charge as per Section 9 German Batteries Act. You thus meet statutory obligations and help to protect the environment. The pedelec, battery, motor, display screen and charger are recyclable materials. You must dispose of and recycle them separately from the domestic waste in compliance with applicable statutory regulations. Separate collection and recycling saves reserves of raw materials and ensures that all the regulations for protection of health and the environment are adhered to when recycling the product and/or the battery.

- ▶ Never dismantle the pedelec, batteries or charger for disposal.
- ▶ The pedelec, display screen, the unopened and undamaged battery and the charger can be returned to any specialist dealer free of charge. Depending on the region, further disposal options may be available.
- ▶ Store the individual parts of the decommissioned pedelec in a dry place, free from frost, where they are protected from direct sunlight.

# 11 Documents

## 11.1 Parts list

### 11.1.1 PASERO PRO I-12

21-Q-0023 (Diamant), 21-Q-0024 (Trapez), 21-Q-0025 (central tube)

Model name	Pasero Pro I-12
Fork	SR Suntour NCX- D, 63 mm deflection, air-suspended, lockout, 15 mm quick release axle
Headset	Integrated tapered
Handlebars	Satori Wien, AL, 31.8 mm, 15° backsweep
Handles	Ergon GP10
Stem	A-head, adjustable
Saddle	Trekking Comodoro, Hydro Foam
Seat post	Kalloy SP-383, AL, 300 mm, Ø30.9 mm, deflection 45 mm
Saddle clamp	QR, black
Crank set	FSA CK-745
Pedals	Marwi SP828, AL
Rear derailleur	Shimano Deore XT RD-M8100
Shifter	Shimano Deore XT SL-M8100
Cassette/cassette sprocket	Shimano SLX, CS-M7100 10-51T
Chain	Shimano CN-M7100
Brake system	Hydraulic disc brake
Front brake	Shimano MT420
Front brake lever	Shimano BL-MT402
Disc, front	Shimano SM-RT30/180mm
Rear brake	Shimano MT420
Rear brake lever	Shimano BL-MT402
Disc, rear	Shimano RT-EM300, lockring, 180 mm
Front rim	DB-Z21
Rear rim	DB-Z21
Hub, front	Shimano MT400, 15 mm quick release axle, centre lock
Hub, rear	Shimano MT510, 12 mm quick release axle, centre lock
Spokes	Stainless steel, black, 2 mm/RW: 2.34 mm
Tyres	Schwalbe Marathon Almotion, 50-622, RaceGuard
Hose	Schwalbe DV 19
Front lamp	HERCULES, FH 100, LED, up to 100 lux
Rear lamp	Comus RZ-100EB, LED, pannier rack rear light
Pannier rack	i-Rack, with spring flap
Guards	SKS, EDGE AL 56, AL
Chain guard	Horn Catena 17
Lock	ABUS battery lock
Kickstand	Pletscher Comp Flex 40
Motor	Brose Drive S-MAG
Rechargeable battery	BMZ Supercore 750
Display	BMZ Supercore 750
Charger	Brose Topology DS103

## 11.1.2 PASERO COMP I-12

21-Q-0026 (Diamant), 21-Q-0027 (Trapez), 21-Q-0028 (central tube)

Model name	Pasero Comp I-12
Fork	SR Suntour NCX- D, 63 mm deflection, air-suspended, lockout, 15 mm quick release axle
Headset	Integrated tapered
Handlebars	Satori Wien, AL, 31.8 mm, 15° backsweep
Handles	Ergon GP10
Stem	A-head, adjustable
Saddle	Trekking Comodoro, Hydro Foam
Seat post	Kalloy SP-383, AL, 300 mm, Ø30.9 mm, deflection 45 mm
Saddle clamp	QR, black
Crank set	FSA CK-745
Pedals	Marwi SP828, AL
Rear derailleur	Shimano Deore RD-M6100
Shifter	Shimano Deore SL-M6100
Cassette/cassette sprocket	Shimano Deore, CS-M6100 10-51T
Chain	Shimano CN-M6100
Toothed belt	
Back-pedal brake	No
Brake system	Hydraulic disc brake
Front brake	Shimano MT410
Front brake lever	Shimano BL-MT402
Disc, front	Shimano SM-RT30/180mm
Rear brake	Shimano MT410
Rear brake lever	Shimano BL-MT402
Disc, rear	Shimano RT-EM300, lockring, 180 mm
Front rim	Ryde Taurus 2000
Rear rim	Ryde Taurus 2000
Hub, front	Shimano MT400, 15 mm quick release axle, centre lock
Hub, rear	Formula FQR-12E, quick release axle 12 mm, centre lock
Spokes	Stainless steel, black, 2 mm/RW: 2.34 mm
Tyres	SUPERO Optima Safe, 47-622, C-3031
Hose	CST
Front lamp	HERCULES, FH 40, LED, up to 40 lux
Rear lamp	Comus RZ-100EB, LED, pannier rack rear light
Pannier rack	i-Rack, with spring flap
Guards	SKS, EDGE AL 56, AL
Chain guard	Horn Catena 17
Lock	ABUS battery lock
Kickstand	Pletscher Comp Flex 40
Motor	Brose Drive S-MAG
Rechargeable battery	BMZ Supercore 750
Display	Typology TFT Center Display, with remote controller
Charger	Brose Topology DS103

### 11.1.3 PASERO COMP I-F5

21-Q-0029 (Diamant), 21-Q-0030 (central tube)

Model name	Pasero Comp I-F5
Fork	SR Suntour NCX- D, 63 mm deflection, air-suspended, lockout, 15 mm quick release axle
Headset	Integrated tapered
Handlebars	Satori Wien, AL, 31.8 mm, 15° backsweep
Handles	Ergon GP10-L
Stem	A-head, adjustable
Saddle	Trekking Comodoro, Hydro Foam
Seat post	Kalloy SP-383, AL, 300 mm, Ø30.9 mm, deflection 45 mm
Saddle clamp	QR, black
Crank set	FSA CK-745
Pedals	Marwi SP828, AL
Rear derailleur	
Shifter	Shimano Revoshifter
Cassette/cassette sprocket	Gates CDX 28T
Chain	
Toothed belt	Gates CDX
Back-pedal brake	No
Brake system	Hydraulic disc brake
Front brake	Shimano MT410
Front brake lever	Shimano BL-MT402
Disc, front	Shimano SM-RT30/180mm
Rear brake	Shimano MT410
Rear brake lever	Shimano BL-MT402
Disc, rear	Shimano RT-EM300, lockring, 180 mm
Front rim	Ryde Taurus 2000
Rear rim	Ryde Taurus 2000
Hub, front	Shimano MT400, 15 mm quick release axle, centre lock
Hub, rear	Shimano Nexus 5-speed, freewheel
Spokes	Stainless steel, black, 2 mm/RW: 2.34 mm
Tyres	SUPERO Optima Safe, 47-622, C-3031
Hose	CST
Front lamp	HERCULES, FH 40, LED, up to 40 lux
Rear lamp	Comus RZ-100EB, LED, pannier rack rear light
Pannier rack	i-Rack, with spring flap
Guards	SKS, EDGE AL 56, AL
Chain guard	Horn Catena 17
Lock	ABUS battery lock
Kickstand	Pletscher Comp Flex 40
Motor	Brose Drive S-MAG
Rechargeable battery	BMZ Supercore 750
Display	Typology TFT Center Display, with remote controller
Charger	Brose Topology DS103

### 11.1.4 PASERO SPORT I-10

21-Q-0031 (Diamant), 21-Q-0032 (Trapez), 21-Q-0033 (central tube)

Model name	Pasero Sport I-10
Fork	SR Suntour NEX-E25 HLO, 63 mm deflection, adjustable, lockout
Headset	Integrated tapered
Handlebars	Satori Wien, AL, 31.8 mm, 15° backsweep
Handles	Ergo, with integrated clamping
Stem	A-head, adjustable
Saddle	Trekking Comodoro, Hydro Foam
Seat post	Kalloy SP-383, AL, 300 mm, Ø30.9 mm, deflection 45 mm
Saddle clamp	QR, black
Crank set	FSA CK-745
Pedals	Marwi SP828, AL
Rear derailleur	Shimano Deore RD-M5120
Shifter	Shimano Deore SL-M4100
Cassette/cassette sprocket	Shimano Deore, CS-M4100 11-46T
Chain	KMC E10S
Toothed belt	
Back-pedal brake	No
Brake system	Hydraulic disc brake
Front brake	Shimano MT200
Front brake lever	Shimano BL-MT201
Disc, front	Shimano SM-RT30/180mm
Rear brake	Shimano MT200
Rear brake lever	Shimano BL-MT201
Disc, rear	Shimano RT-EM300, lockring, 180 mm
Front rim	Ryde Taurus 2000
Rear rim	Ryde Taurus 2000
Hub, front	Shimano M3050, quick release, centre lock
Hub, rear	Shimano M3050, quick release, centre lock
Spokes	Stainless steel, black, 2 mm/RW: 2.34 mm
Tyres	SUPERO Optima Safe, 47-622, C-3031
Hose	CST
Front lamp	HERCULES, FH 40, LED, up to 40 lux
Rear lamp	Comus RZ-100EB, LED, pannier rack rear light
Pannier rack	i-Rack, with spring flap
Guards	SKS, A56, plastic
Chain guard	Horn Catena 17
Lock	ABUS battery lock
Kickstand	Pletscher Comp Flex 40
Motor	Brose Drive S-MAG
Rechargeable battery	BMZ Supercore 750
Display	Typology TFT Center Display, with remote controller
Charger	Brose Topology DS103



### 11.1.5 PASERO SUV I-10

21-Q-0079 (Diamant), 21-Q-0080 (central tube)

Model name	Pasero SUV I-10
Fork	SR Suntour Lytro 35 Supreme, 120 mm deflection, air-suspended, lockout, 15 mm quick release axle
Headset	Integrated tapered
Handlebars	MTB Riser, AL, 31.8 mm
Handles	Ergo, with integrated clamping
Stem	A-head
Saddle	Selle Royal Vivo Ergo
Seat post	Kalloy SP-368, AL, 350 mm, Ø30.9 mm, deflection 45 mm
Saddle clamp	QR, black
Crank set	Samox EC40-BR1
Pedals	Wellgo
Rear derailleur	Shimano Deore RD-M5120
Shifter	Shimano Deore SL-M4100-IR
Cassette/cassette sprocket	Shimano Deore, CS-M4100 11-46T
Chain	Shimano CN-HG54
Toothed belt	
Back-pedal brake	No
Brake system	Hydraulic disc brake
Front brake	Shimano MT420
Front brake lever	Shimano BL-MT4100
Disc, front	Shimano SM-RT64/203mm
Rear brake	Shimano MT420
Rear brake lever	Shimano BL-MT4100
Disc, rear	Shimano RT-EM600, lockring, 180 mm
Front rim	AS-T30-N
Rear rim	AS-T30-N
Hub, front	Shimano MT410-B, 15 mm quick release axle, centre lock
Hub, rear	Shimano MT400-B, 12 mm quick release axle, centre lock
Spokes	Stainless steel, black, 2 mm/RW: 2.34 mm
Tyres	Schwalbe G-One Performance, 57-584
Hose	Schwalbe SV 21
Front lamp	HERCULES, FH 40, LED, up to 40 lux
Rear lamp	Comus RZ-100EB, LED, pannier rack rear light
Pannier rack	i-Rack, with spring flap
Guards	Sunny Wheel, 70mm, AL
Chain guard	
Lock	ABUS battery lock
Kickstand	Pletscher Comp Flex 40
Motor	Brose Drive S-MAG
Rechargeable battery	BMZ Supercore 750
Display	Typology TFT Center Display, with remote controller
Charger	Brose Topology DS103



## 11.2 Assembly report

Date:

Frame number:

Components	Description		Criteria		Measures if rejected
	Assembly/inspection	Tests	Acceptance	Rejection	
Front wheel	Assembly		O.K.	Loose	Adjust quick release
Kickstand	Check mount fastening	Functional check	O.K.	Loose	Retighten screws
Tyres		Tyre pressure check	O.K.	Tyre pressure too low/ too high	Adjust tyre pressure
Frame	Check for damage – fracture, scratches		O.K.	Damage detected	<i>Take out of operation, new frame</i>
Handles, coverings	Check mount fastening		O.K.	Not provided	Retighten screws, new handles or coverings as specified in parts list
Handlebars, stem	Check mount fastening		O.K.	Loose	Retighten screws; new stem as specified in parts list if necessary
Steering headset	Check for damage	Functional check	O.K.	Loose	Retighten screws
Saddle	Check mount fastening		O.K.	Loose	Retighten screws
Seat post	Check mount fastening		O.K.	Loose	Retighten screws
Protective plate	Check mount fastening		O.K.	Loose	Retighten screws
Pannier rack	Check mount fastening		O.K.	Loose	Retighten screws
Attachments	Check mount fastening		O.K.	Loose	Retighten screws
Bell		Functional check	O.K.	No ring, too quiet, missing	New bell as specified in the parts list
<b>Suspension elements</b>					
Fork, suspension fork	Check for damage		O.K.	Damage detected	New fork as specified in the parts list
Rear frame damper	Check for damage		O.K.	Damage detected	New fork as specified in the parts list
Suspension seat post	Check for damage		O.K.	Damage detected	New fork as specified in the parts list
<b>Brake system</b>					
Brake lever	Check mount fastening		O.K.	Loose	Retighten screws
Brake fluid	Check fluid level		O.K.	Too little	Refill with brake fluid; new brake hoses if damaged
Brake linings	Check brake linings, brake discs or rims for damage		O.K.	Damage detected	New brake linings, brake discs or rims
Back-pedal brake braking armature	Check mount fastening		O.K.	Loose	Retighten screws
<b>Light system</b>					
Rechargeable battery	First examination		O.K.	Error message	<i>Take out of service</i> ; contact battery manufacturer, new battery
Light cabling	Connections, correct wiring		O.K.	Cable defective, no light	New cabling
Rear light	Side light	Functional check	O.K.	No constant light	<i>Take out of service</i> ; new rear light as specified in parts list; replace if necessary
Front light	Side light, daytime riding light	Functional check	O.K.	No constant light	<i>Take out of service</i> ; new front light as specified in parts list; replace if necessary
Reflectors	All complete, state, fastening		O.K.	Damaged or not all complete	New reflectors

Components	Description			Criteria	Measures if rejected
<b>Drive/gear shift</b>					
<b>Chain/cassette/pinion/chainring</b>	Check for damage		O.K.	Damage	Refasten if necessary or replace as specified in parts list
<b>Chain guard/spoke guard</b>	Check for damage		O.K.	Damage	Replace as specified in parts list
<b>Bottom bracket axle/crank</b>	Check mount fastening		O.K.	Loose	Retighten screws
<b>Pedals</b>	Check mount fastening		O.K.	Loose	Retighten screws
<b>Shifter</b>	Check mount fastening	Functional check	O.K.	Loose	Retighten screws
<b>Shift cables</b>	Check for damage	Functional check	O.K.	Loose or defective	Adjust shift cables; new shift cables if necessary
<b>Front derailleur</b>	Check for damage	Functional check	O.K.	Gear shift difficult or not possible	Adjust
<b>Rear derailleur</b>	Check for damage	Functional check	O.K.	Gear shift difficult or not possible	Adjust
<b>Electric drive</b>					
<b>Display</b>	Check for damage	Functional check	O.K.	No screen, defective screen display	Restart, test battery, new software, or new display – <i>take out of service</i> ,
<b>Electric drive control panel</b>	DriveCheck for damage	Functional check	O.K.	No response	Restart; contact control panel manufacturer, new control panel
<b>Tachometer</b>		Speed measurement	O.K.	Pedelec travelling 10% too fast/slow	Take pedelec out of service until the source of the error is found
<b>Cabling</b>	Visual inspection		O.K.	Failure in system, damage, kinked cables	New cabling
<b>Battery mount</b>	Firmly in position, lock, contacts	Functional check	O.K.	Loose; lock doesn't close, no contacts	New battery mount
<b>Motor</b>	Visual inspection and mount		O.K.	Damage, loose	Refasten motor, contact motor manufacturer, new motor
<b>Software</b>	Check version		In latest version	Not latest version	Import update

### Technical inspection, checking safety, test ride

Components	Description			Criteria	Measures if rejected
	Assembly/inspection	Tests	Acceptance	Rejection	
<b>Brake system</b>		Functional check	O.K.	No full braking; braking distance too long	Locate defective part in brake system and correct
<b>Gear shift under operating load</b>		Functional check	O.K.	Problems when shifting gear	Readjust gear shift
<b>Suspension components (fork, shock absorber, seat post)</b>		Functional check	O.K.	Suspension too deep or no longer exists	Locate defective component and correct
<b>Electric drive</b>		Functional check	O.K.	Loose connection, problems when riding, accelerate	Locate defective part in electric drive and correct
<b>Light system</b>		Functional check	O.K.	No continuous light, too bright	Locate defective part in light system and correct
<b>Test ride</b>			No strange noises	Strange noises	Locate source of noise and correct

Date:

Fitter's name:

Final inspection by workshop manager



## 11.3 Maintenance instructions

### Diagnosis and documentation of current status

Date:

Frame number:

Components	Frequency	Description			Criteria		Measures if rejected
		Inspection	Tests	Maintenance	Acceptance	Rejection	
Front wheel	6 months	Assembly			O.K.	Loose	Adjust quick release
Kickstand	6 months	Check mount fastening	Functional check		O.K.	Loose	Retighten screws
Tyres	6 months		Tyre pressure check		O.K.	Tyre pressure too low/too high	Adjust tyre pressure
Frame	6 months	Check for damage – fracture, scratches			O.K.	Damage detected	Take pedelec out of service, new frame
Handles, coverings	6 months	Wear; check if fastened securely			O.K.	Not provided	Retighten screws, new handles or coverings as specified in parts list
Handlebars, stem	6 months	Check mount fastening			O.K.	Loose	Retighten screws; new stem as specified in parts list if necessary
Steering headset	6 months	Check for damage	Functional check	Lubricating and adjustment	O.K.	Loose	Retighten screws
Saddle	6 months	Check mount fastening			O.K.	Loose	Retighten screws
Seat post	6 months	Check mount fastening			O.K.	Loose	Retighten screws
Protective plate	6 months	Check mount fastening			O.K.	Loose	Retighten screws
Pannier rack	6 months	Check mount fastening			O.K.	Loose	Retighten screws
Attachments	6 months	Check mount fastening			O.K.	Loose	Retighten screws
Bell	6 months		Functional check		O.K.	No ring, too quiet, missing	New bell as specified in the parts list
<b>Suspension elements</b>							
Fork, suspension fork	To manufacturer's specifications*	Check for damage – corrosion, fracture		Maintenance as specified by manufacturer Lubrication, oil change as specified by manufacturer	O.K.	Damage detected	New fork as specified in the parts list
Rear frame damper	To manufacturer's specifications*	Check for damage – corrosion, fracture		Maintenance as specified by manufacturer Lubrication, oil change as specified by manufacturer	O.K.	Damage detected	New fork as specified in the parts list
Suspension seat post	To manufacturer's specifications*	Check for damage		Maintenance as specified by manufacturer	O.K.	Damage detected	New fork as specified in the parts list
<b>Brake system</b>							
Brake lever	6 months	Check mount fastening			O.K.	Loose	Retighten screws
Brake fluid	6 months	Check fluid level		Depending on time of year	O.K.	Too little	Top up brake fluid; <i>take Pedelec out of service</i> if damaged; new brake hoses
Brake linings	6 months	Check brake linings, brake discs or rims for damage			O.K.	Damage detected	New brake linings, brake discs or rims
Back-pedal brake braking armature	6 months	Check mount fastening			O.K.	Loose	Retighten screws
Brake system	6 months	Check mount fastening		Functional check	O.K.	Loose	Retighten screws

\* see Section 8.1

Components	Frequency	Description			Criteria		Measures if rejected
		Inspection	Tests	Maintenance	Acceptance	Rejection	
<b>Light system</b>							
<b>Rechargeable battery</b>	6 months	First examination			O.K.	Error message	Contact battery manufacturer; <i>take out of service</i> , new battery
<b>Light cabling</b>	6 months	Connections, correct wiring			O.K.	Cable defective, no light	New cabling
<b>Rear light</b>	6 months	Side light	Functional check		O.K.	No constant light	New rear light as specified in parts list; replace if necessary
<b>Front light</b>	6 months	Side light, daytime riding light	Functional check		O.K.	No constant light	New front light as specified in parts list; replace if necessary
<b>Reflectors</b>	6 months	All complete, state, fastening			O.K.	Damaged or not all complete	New reflectors
<b>Drive/gear shift</b>							
<b>Chain/cassette/pinion/chainring</b>	6 months	Check for damage			O.K.	Damage	Refasten if necessary or replace as specified in parts list
<b>Chain guard/spoke guard</b>	6 months	Check for damage			O.K.	Damage	Replace as specified in parts list
<b>Bottom bracket axle/crank</b>	6 months	Check mount fastening			O.K.	Loose	Retighten screws
<b>Pedals</b>	6 months	Check mount fastening			O.K.	Loose	Retighten screws
<b>Shifter</b>	6 months	Check mount fastening	Functional check		O.K.	Loose	Retighten screws
<b>Shift cables</b>	6 months	Check for damage	Functional check		O.K.	Loose or defective	Adjust shift cables; new shift cables if necessary
<b>Front derailleur</b>	6 months	Check for damage	Functional check		O.K.	Gear shift difficult or not possible	Adjust
<b>Rear derailleur</b>	6 months	Check for damage	Functional check		O.K.	Gear shift difficult or not possible	Adjust
<b>Electric drive</b>							
<b>Display</b>	6 months	Check for damage	Functional check		O.K.	No screen, defective screen display	Restart, test battery, new software, or new display – <i>take out of service</i> ,
<b>Electric drive control panel</b>	6 months	DriveCheck for damage	Functional check		O.K.	No response	Restart; contact control panel manufacturer, new control panel
<b>Tachometer</b>	6 months		Speed measurement		O.K.	Pedelec travelling 10% too fast/slow	Take pedelec out of service until the source of the error is found
<b>Cabling</b>	6 months	Visual inspection			O.K.	Failure in system, damage, kinked cables	New cabling
<b>Battery mount</b>	6 months	Firmly in position, lock, contacts	Functional check		O.K.	Loose; lock doesn't close, no contacts	New battery mount
<b>Motor</b>	6 months	Visual inspection and mount			O.K.	Damage, loose	Refasten motor, contact motor manufacturer, new motor; <i>take out of service</i>
<b>Software</b>	6 months	Check version			In latest version	Not latest version	Import update

### Technical inspection, checking safety, test ride

Components	Description		Criteria		Measures if rejected
	Assembly/inspection	Tests	Acceptance	Rejection	
<b>Brake system</b>	6 months	Functional check	O.K.	No full braking; braking distance too long	Locate defective part in brake system and correct
<b>Gear shift under operating load</b>	6 months	Functional check	O.K.	Problems when shifting gear	Readjust gear shift
<b>Suspension components (fork, shock absorber, seat post)</b>	6 months	Functional check	O.K.	Suspension too deep or no longer exists	Locate defective component and correct
<b>Electric drive</b>	6 months	Functional check	O.K.	Loose connection, problems when riding, accelerate	Locate defective part in electric drive and correct
<b>Light system</b>	6 months	Functional check	O.K.	No continuous light, too bright	Locate defective part in light system and correct
<b>Test ride</b>	6 months	Functional check	No strange noises	Strange noises	Locate source of noise and correct

Date:	
Fitter's name:	
Final inspection by workshop manager	

#### Notes

**Notes**



## 11.4 SuperCore drilling template

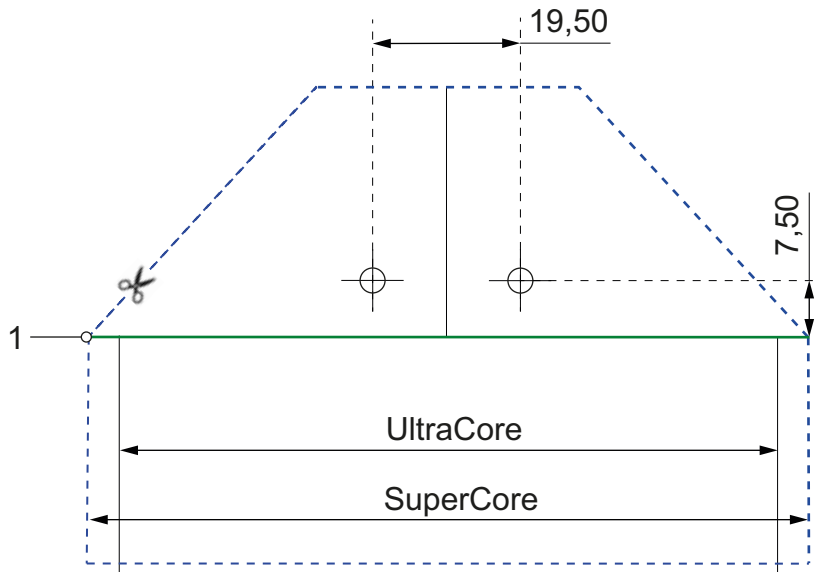



## 12 Glossary

### Brake lever

*Source: EN 15194:2017:* lever used to apply the brake.

### Braking distance

*Source: EN 15194:2017:* distance travelled by a pedelec between the commencement of braking and the point at which the pedelec comes to rest.

### Cargo bike

*Source: DIN 79010:* bicycle mainly designed to carry goods.

### CE marking

*Source: Directive 2006/42/EC on Machinery:* the manufacturer uses the CE marking to declare that the Pedelec complies with the applicable requirements.

### City and trekking bicycles

*Source: EN-ISO 4210 - 2:* pedelec designed for use on public roads primarily for means of transportation or leisure.

### Consumables

*Source: EN 82079-1:* any part or material that is necessary for continued use or maintenance of the product.

### Decommissioning

*Source: DIN 31051:* intentional, unlimited interruption in an object's functional capability.

### Disc brake

*Source: EN 15194:2017:* brake in which brake pads are used to grip the lateral faces of a thin disc attached to or incorporated in the wheel hub.

### Drive belt

*Source: EN 15194:2017:* seamless ring belt which is used as a means of transmitting motive force.

### Electrical control system

*Source: EN 15194:2017:* electronic and/or electrical component, or an assembly of components provided for installation into a vehicle, together with all electrical connections and associated wiring for the motor electrical power assistance.

### Electrically power assisted cycle, pedelec

*Source: EN 15194:2017:* electrically power assisted cycle, equipped with pedals and an auxiliary electric motor, which cannot be propelled exclusively by means of the auxiliary electric motor, except in start-up assistance mode.

### Fault

*Source: EN 13306:2018-02, 6.1:* state of an item (4.2.1) characterized by inability to perform a required function (4.5.1), excluding the inability during preventive maintenance or other planned actions, or due to lack of external resources.

### Folding bicycle

*Source: EN-ISO 4210-2:* bicycle designed to fold into a compact form, facilitating transport and storage.

### Fork steerer

*Source: EN 15194:2017:* part of a fork that rotates about the steering axis of a bicycle frame head tube. It is normally connected to the fork crown or directly to the fork legs, and is normally the point of connection between the fork and the handlebar stem.

### Fracture

*Source: EN 15194:2017:* unintentional separation into two or more parts.

### Instruction handbook

*Source: ISO/FDIS 20607:2018:* part of the user information that machine manufacturers provide to machine operators; it contains guidance, instructions and tips related to the use of the machine in all its life cycle phases.

### Maintenance

*Source: DIN 31051:* maintenance is generally performed at regular intervals and often carried out by trained technical staff. This ensures a maximum service life and low wear and tear for the maintained items. Proper maintenance is often also a pre-requisite for providing a warranty.

### Maximum continuous power

*Source: ZEG:* the maximum continuous power is the maximum power for the electric motor output shaft during 30 minutes.

**Maximum saddle height**

*Source: EN 15194:2017:* vertical distance from the ground to the point where the top of the seat surface is intersected by the seat-post axis, measured with the saddle in a horizontal position and with the seat-post set to the minimum insertion-depth mark.

**Maximum tyre pressure**

*Source: EN 15194:2017:* maximum tyre pressure recommended by the tyre or rim manufacturer for a safe and efficient performance. If the rim and tyre both indicate a maximum tyre pressure, the maximum inflation pressure is the lower of the two pressures indicated.

**Minimum insertion depth mark**

*Source: EN 15194:2017:* mark indicating the minimum insertion-depth of handlebar stem into fork steerer (fork stem) or seat post into frame.

**Model year**

*Source: ZEG:* the model year refers to the first production year that the series-manufactured pedelec was manufactured in the version in question and is not always identical with the year of manufacture. The year of manufacture may be before the model year in some cases. If no technical modifications are introduced to the series, production may continue of pedelecs from a previous model year.

**Mountain bike**

*Source: EN-ISO 4210-2:* bicycle designed for use off-road on rough terrain, on public roads, and on public pathways, equipped with a suitably strengthened frame and other components, and, typically, with wide-section tyres with coarse tread patterns and a wide range of transmission gears.

**Off-road rough terrain**

*Source: EN 15194:2017:* coarse pebble tracks, forest trails, and other general off-road tracks where tree roots and rocks are likely to be encountered.

**Permitted total weight**

*Source: EN 15194:2017:* weight of the fully assembled pedelec plus the rider and baggage, as specified by the manufacturer.

**Quick-release device, quick release**

*Source: EN 15194:2017:* lever actuated mechanism that connects, retains or secures a wheel or any other component.

**Racing bicycle**

*Source: EN-ISO 4210-2:* bicycle intended for high-speed amateur use on public roads having a steering assembly with multiple grip positions allowing for an aerodynamic posture, a multi-speed transmission system, tyre width not greater than 28 mm and a maximum mass of 12 kg for the fully assembled bicycle.

**Seat post**

*Source: EN 15194:2017:* component that clamps the saddle (with a bolt or assembly) and connects it with the frame.

**Shut-off speed**

*Source: EN 15194:2017:* speed reached, by the pedelec, at the moment the current has dropped to zero or to the no load current value.

**Spare part**

*Source: EN 13306:2018-02, 3.5:* item intended to replace a corresponding item in order to retain or maintain the original required function of the item.

**Suspension fork**

*Source: EN 15194:2017:* front fork incorporating controlled, axial flexibility to reduce the transmission of road-shocks to the rider.

**Suspension frame**

*Source: EN 15194:2017:* frame incorporating controlled, vertical flexibility to reduce the transmission of road-shocks to the rider.

**Type number**

*Source: ZEG:* all pedelec models have an eight-digit type number which is used to specify the design model year, the type of pedelec and the version.

**Wear**

*Source: DIN 31051:* reduction in useful life (4.3.4), caused by chemical and/or physical processes.

**Weight of ready-to-ride bicycle**

*Source: ZEG:* the indicated weight for a ready-to-ride bicycle refers to the weight of a pedelec at the time of sale. The weight of each additional accessory must be added to this weight.

**Wheel**

*Source: EN 15194:2017:* assembly or combination of hub, spokes or disc, and rim, but excluding tyre assembly.

**Work environment**

*Source: EN ISO 9000:2015:* set of conditions under which work is performed.

**Year of manufacture**

*Source: ZEG:* the year of manufacture is the year in which the Pedelec was manufactured. The production period is always from August to July of the following year.

**Young adult bicycle**

*Source: EN-ISO 4210-2:* bicycle designed for use on public roads by a young adult whose weight is less than 40 kg, with maximum saddle height of 635 mm or more and less than 750 mm. (see ISO 4210).

**12.1 Abbreviations**

ABS anti-blocking system

ECP electronic cell protection

**12.2 Simplified terms**

The following terms are used for better legibility:

Term	Meaning
Operating instructions	Original operating instructions
Motor	Drive motor, sub-system

**Table 40: Simplified terms**

## 13 Appendix

### I. Translation of the original EC/EU Declaration of Conformity

#### Manufacturer

ZEG Zweirad-Einkaufs-Genossenschaft eG  
 Longericher Strasse 2  
 50739 Köln, Germany

#### Authorised representative for documentation\*

Janine Otto  
 c/o ZEG Zweirad-Einkaufs-Genossenschaft eG  
 Longericher Strasse 2  
 50739 Köln, Germany

The machine, pedelec types:

21-Q-0023	PASERO PRO I-12 (Diamant)	City and trekking bicycle
21-Q-0024	PASERO PRO I-12 (Trapez)	City and trekking bicycle
21-Q-0025	PASERO PRO I-12 (central tube)	City and trekking bicycle
21-Q-0026	PASERO COMP I-12 (Diamant)	City and trekking bicycle
21-Q-0027	PASERO COMP I-12 (Trapez)	City and trekking bicycle
21-Q-0028	PASERO COMP I-12 (central tube)	City and trekking bicycle
21-Q-0029	PASERO COMP I-F5 (Diamant)	City and trekking bicycle
21-Q-0030	PASERO COMP I-F5 (central tube)	City and trekking bicycle
21-Q-0031	PASERO SPORT I-10 (Diamant)	City and trekking bicycle
21-Q-0032	PASERO SPORT I-10 (Trapez)	City and trekking bicycle
21-Q-0033	PASERO SPORT I-10 (central tube)	City and trekking bicycle
21-Q-0079	PASERO SUV I-10 (Diamant)	City and trekking bicycle
21-Q-0080	PASERO SUV I-10 (central tube)	City and trekking bicycle

Year of manufacture 2020 and year of manufacture 2021, complies with the following applicable EU provisions:

- Machinery Directive 2006/42/EC
- RoHS Directive 2011/65/EU
- Electromagnetic Compatibility Directive 2014/30/EU.

The safety objectives in the Low Voltage Directive 2014/35/EU have been met in compliance with Appendix I, No. 1.5.1 of the Machinery Directive 2006/42/EC.

The following harmonised standards have been applied:

- ISO 20607:2018 Safety machinery – Instruction handbook – General drafting principles
- EN 15194:2017, Cycles – Electrically power assisted cycles – EPAC Bicycles

The following other technical standards have been applied:

- EN 11243:2016, Cycles – Luggage carriers for bicycles – Requirements and test methods



Cologne, 29/07/2020

.....  
 Egbert Hageböck, Chairman, ZEG Zweirad-Einkaufs-Genossenschaft eG

\* Community member who is authorised to compile the technical documentation

## 14 Keyword index

### A

- Alternative equipment, 107
- Articulated shaft,
  - care 72

### B

- Basic cleaning 70
- Battery, 19, 20
  - checking, 35
  - cleaning, 71
  - disposing of, 92
  - remove, 52
  - shipping 32
  - transporting 32
  - waking, 56
- Belt tension, 75
- Brake calliper, 18
- Brake disc, 18
  - check 74
- Brake lever, 26
- Brake lining, 18
  - check 74
  - maintaining, 74
- Brake,
  - check brake cables 75
  - check brake disc 74
  - check brake linings 74
  - check pressure point 74
  - securing during transport 32
- Break in operation, 33
  - carrying out 33
  - preparing 33

### C

- Cassette,
  - care 72
- Chain drive, 19
- Chain guard,
  - checking, 53
- Chain tension, 75
- Chain wheel, 19
- Chain wheels,
  - care 72
- Chain, 14, 19
  - care, 72
  - maintaining, 75
- Charger,
  - disposing of, 92
- Child seat, 50

### D

- Dimensions, 31
- Direction of travel, 19
- Display,
  - cleaning, 71
- Drive system, 19
  - switching on, 57, 58

### E

- Electrical cable,
  - check 75
- Emergency stop system 12

### F

- Fork, 15
  - care, 72
- Frame battery,
  - remove, 52

- Frame, 14
  - care, 72
  - cleaning, 70
- Front derailleur,
  - care, 72
- Front wheel brake, 18
  - braking, 64
- Front wheel, see Wheel

### G

- Gear shift twist grip, 26
  - checking, 75
- Gear shift,
  - check 75
  - maintaining, 75
  - switching, 67, 68

### H

- Handlebars, 14, 26
  - check 37
- Headlight, 19
- Hub, 15

### I

- Initial commissioning, 34

### J

- Jockey wheel,
  - care 72
- Journey information,
  - resetting, 60

### L

- Level of assistance, 27, 28, 56
  - selecting, 59

### M

- Minimum insertion depth marking, 44
- Model year, 8
- Motor, 19
  - cleaning, 71
- Mudguards,
  - checking, 53

### O

- On-board computer battery,
  - charging the battery, 58
- On-board computer, 20
  - store 33
  - switching on 58
- On-screen indicator, 26, 27, 28, 51, 59, 60, 61, 62, 63

### P

- Pannier rack, 14
  - changing, 54
  - checking, 53
  - using, 54
- Pedal, 19
  - care, 72
  - cleaning, 69

- Pedelec,
  - shipping 32
  - transporting 32
- Push assist,
  - using, 59

### R

- Rear frame damper,
  - cleaning, 69, 70

- Rear light, 19
- Rear wheel brake, 18
- Riding light, 20
  - checking function, 53
- Rim, 15
  - checking, 73
- Rim, tyres,
  - check 73

### S

- Saddle, 14, 54
  - changing the saddle tilt, 43
  - changing the seat length, 44
  - determining the saddle height, 43, 44
  - using, 54
- Seat post, 14
- Shifter,
  - checking, 75
  - setting, 80
- Spoke, 15
- Stem,
  - care, 72
  - check 37, 75
  - cleaning, 70
- Suspension fork,
  - cleaning, 69
- System message, 28
- System setting,
  - changeable, 28, 60

### T

- Trailer, 51
- Transportation, 31
- Transporting, see Transportation
- Type number, 8
- Tyres, 15
  - check 73
  - check tyre pressure 73
  - checking, 73
  - converting 52
  - Airless 52
  - Tubeless 52

### V

- Valve, 15
  - Dunlop valve, 15
  - Presta valve, 15
  - Schrader valve, 15

### W

- Weight,
  - shipping weight, 31
  - Weight, 31
  - permitted total weight, 8
- Wheel,
  - cleaning, 70
  - installing 36
  - maintaining, 73
- Winter break, see Break in operation